

JVC



COMPACT COMPONENT HDD SYSTEM SYSTEME HDD DE COMPOSANTS COMPACT

NX-HD10

- Consists of CA-NXHD10 and SP-NXHD10
- Composé du CA-NXHD10 et SP-NXHD10

SP-NXHD10

CA-NXHD10

SP-NXHD10

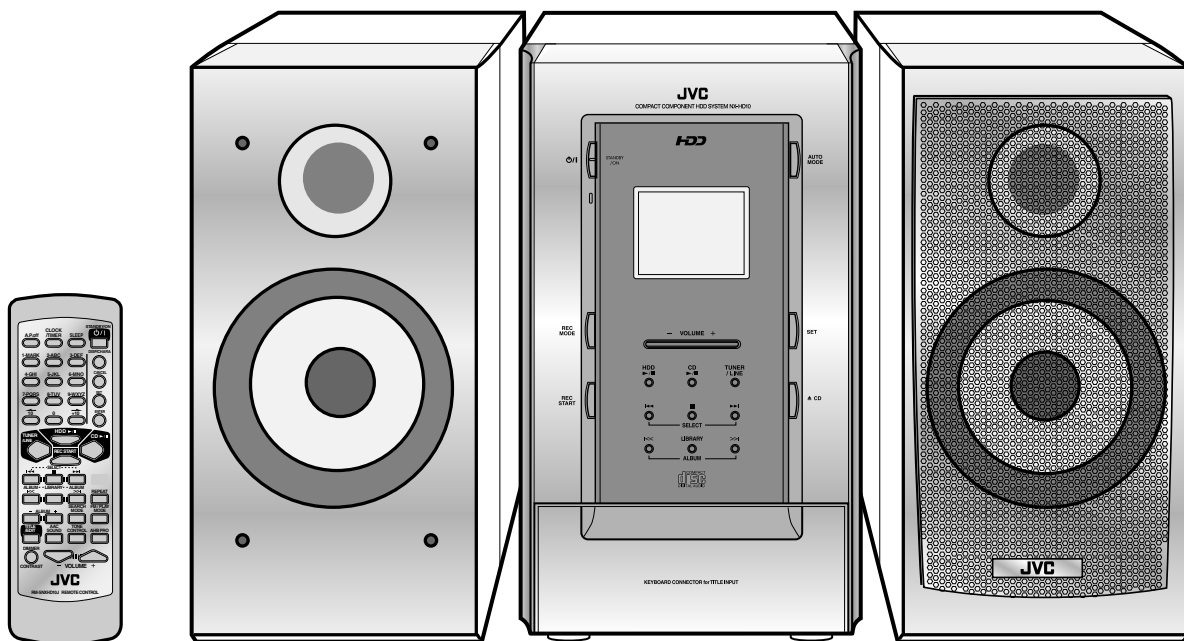

HDD COMPACT
disc
DIGITAL AUDIO

INSTRUCTIONS MANUEL D'INSTRUCTIONS

For Customer Use:

Enter below the Model No. and Serial No. which are located either on the rear, bottom or side of the cabinet. Retain this information for future reference.

Model No. _____

Serial No. _____

LVT0859-001A

[J(C)]

Warnings, Cautions and Others

Mises en garde, précautions et indications diverses

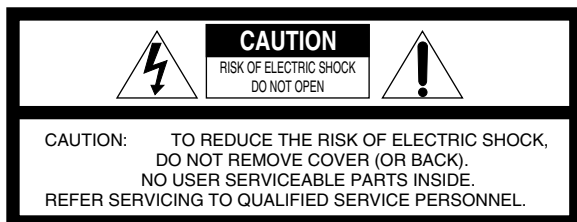

The lightning flash with arrowhead symbol, within an equilateral triangle is intended to alert the user to the presence of uninsulated "dangerous voltage" within the product's enclosure that may be of sufficient magnitude to constitute a risk of electric shock to persons.



The exclamation point within an equilateral triangle is intended to alert the user to the presence of important operating and maintenance (servicing) instructions in the literature accompanying the appliance.

WARNING: TO REDUCE THE RISK OF FIRE OR ELECTRIC SHOCK, DO NOT EXPOSE THIS APPLIANCE TO RAIN OR MOISTURE.

CAUTION

To reduce the risk of electrical shocks, fire, etc.:

1. Do not remove screws, covers or cabinet.
2. Do not expose this appliance to rain or moisture.

ATTENTION

Afin d'éviter tout risque d'électrocution, d'incendie, etc.:

1. Ne pas enlever les vis ni les panneaux et ne pas ouvrir le coffret de l'appareil.
2. Ne pas exposer l'appareil à la pluie ni à l'humidité.

Caution — STANDBY/ON button!

Disconnect the mains plug to shut the power off completely. The STANDBY/ON  button in any position does not disconnect the mains line. The power can be remote controlled.

Attention — Commutateur STANDBY/ON !

Déconnecter la fiche de secteur pour couper complètement le courant. Le commutateur STANDBY/ON  ne coupe jamais complètement la ligne de secteur, quelle que soit sa position. Le courant peut être télécommandé.

Caution

Never try to analyze or retrieve the data stored in the Hard Disk Drive (HDD). Otherwise, you may have your warranty invalid, and be penalized by law. The manufacturer assumes no liability for any damage resulting from such conduct as mentioned above.

Attention

Ne jamais essayer d'analyser ni d'extraire les données qui se trouvent sur le disque dur (HDD). Sinon, votre garantie risquerait d'être invalidée et vous risqueriez d'être pénalisé par la loi. Le fabricant ne peut être tenu responsable pour tout dommage résultant d'une telle conduite.

Note to CATV system installer:

This reminder is provided to call the CATV system installer's attention to Section 820-40 of the NEC which provides guidelines for proper grounding and, in particular, specifies that the cable ground shall be connected to the grounding system of the building, as close to the point of cable entry as practical.

IMPORTANT FOR LASER PRODUCTS

1. CLASS 1 LASER PRODUCT
 2. **CAUTION:** Invisible laser radiation when open and interlock failed or defeated. Avoid direct exposure to beam.
 3. **CAUTION:** Do not open the top cover. There are no user serviceable parts inside the Unit; leave all servicing to qualified service personnel.
-
1. PRODUIT LASER CLASSE 1
 2. **ATTENTION:** Radiation laser invisible quand l'appareil est ouvert ou que le verrouillage est en panne ou désactivé. Eviter une exposition directe au rayon.
 3. **ATTENTION:** Ne pas ouvrir le couvercle du dessus. Il n'y a aucune pièce utilisable à l'intérieur. Laisser à un personnel qualifié le soin de réparer votre appareil.

For U.S.A.

This equipment has been tested and found to comply with the limits for a Class B digital device, pursuant to part 15 of the FCC Rules. These limits are designed to provide reasonable protection against harmful interference in a residential installation.

This equipment generates, uses and can radiate radio frequency energy and, if not installed and used in accordance with the instructions, may cause harmful interference to radio communications. However, there is no guarantee that interference will not occur in a particular installation. If this equipment does cause harmful interference to radio or television reception, which can be determined by turning the equipment off and on, the user is encouraged to try to correct the interference by one or more of the following measures:

Reorient or relocate the receiving antenna.

Increase the separation between the equipment and receiver.

Connect the equipment into an outlet on a circuit different from that to which the receiver is connected.

Consult the dealer or an experienced radio/TV technician for help.

For Canada/pour le Canada

CAUTION: TO PREVENT ELECTRIC SHOCK, MATCH WIDE BLADE OF PLUG TO WIDE SLOT, FULLY INSERT.

ATTENTION: POUR EVITER LES CHOCS ELECTRIQUES, INTRODUIRE LA LAME LA PLUS LARGE DE LA FICHE DANS LA BORNE CORRESPONDANTE DE LA PRISE ET POUSSER JUSQU'AU FOND.

For Canada/pour le Canada

THIS DIGITAL APPARATUS DOES NOT EXCEED THE CLASS B LIMITS FOR RADIO NOISE EMISSIONS FROM DIGITAL APPARATUS AS SET OUT IN THE INTERFERENCE-CAUSING EQUIPMENT STANDARD ENTITLED "DIGITAL APPARATUS," ICES-003 OF THE DEPARTMENT OF COMMUNICATIONS.

CET APPAREIL NUMERIQUE RESPECTE LES LIMITES DE BRUITS RADIOELECTRIQUES APPLICABLES AUX APPAREILS NUMIRIQUES DE CLASSE B PRESCRITES DANS LA NORME SUR LE MATERIEL BROUILLEUR: "APPAREILS NUMERIQUES", NMB-003 EDICTEE PAR LE MINISTRE DES COMMUNICATIONS.

Introduction

We would like to thank you for purchasing one of our JVC products. Before operating this unit, read this manual carefully and thoroughly to obtain the best possible performance from your unit, and retain this manual for future reference.

About This Manual

This manual is organized as follows:

- This manual mainly explains playback and editing operations using the remote control, and the other operations such as recording operations using the buttons on the unit.

You can use the buttons both on the remote control and on the main unit for the same operations if they have the same or similar names (or marks), unless mentioned otherwise.

- The following marks are used in this manual:



Gives you warnings and cautions to prevent from damage or risk of fire/electric shock. Furthermore, gives you information which is not good for obtaining the best possible performance from the unit.



Gives you information and hints you had better know.

Precautions

Installation

This unit has a built-in HDD, which is a device to read minute magnetic changes. The inside of the device is precision components, requiring you to notice the following when installing the unit:

- Install the unit at a place where the following conditions are satisfied:
 - Level, dry and neither too hot nor too cold—between 5°C (41°F) and 35°C (95°F).
 - At an altitude between –300 m (–98 ft) below sea level and + 3048 m (+1000 ft) above sea level.
 - With adequate ventilation to prevent internal heat buildup in the unit.
- Leave sufficient distance between the unit and the TV.
- Keep the speakers away from the TV to avoid interference with TV.



- DO NOT install the unit in a location near heat sources, or in a place subject to direct sunlight, excessive dust or vibration.
- DO NOT place the unit with the side panels top and bottom.

About the built-in HDD

While the unit is turned on, the hard disk is constantly rotating at a high speed. This requires you to notice the following:

- DO NOT impart vibration or shock.
- DO NOT allow anything having strong magnetism or emitting strong electromagnetic waves (cellular phones, etc.) near the unit.
- **DO NOT disconnect the power plug from the wall outlet when the unit is turned on.**

Failure in following the above cautions may damage the HDD (the stored data will be lost and be never restored).

- Since the HDD has its lifetime, it is strongly recommended to make a copy of your important recordings, and keep it using other recording devices.

Power sources

- When unplugging the unit from the wall outlet, always pull the plug, not the AC power cord.



DO NOT handle the AC power cord with wet hands.

Moisture condensation

Moisture may condense on the lens inside the unit in the following cases:

- After starting heating in the room
 - In a damp room
 - If the unit is brought directly from a cold to a warm place
- Should this occur, the unit may malfunction. In this case, leave the unit turned on for a few hours until the moisture evaporates, unplug the AC power cord, then plug it in again.

Others

- Should any metallic object or liquid fall into the unit, unplug the unit and consult your dealer before operating any further.
- If you are not going to operate the unit for an extended period of time, unplug the AC power cord from the wall outlet.



DO NOT disassemble the unit since there are no user serviceable parts inside.

If anything goes wrong, unplug the AC power cord and consult your dealer.

Contents

Location of the Buttons	3	Recording into the HDD	38
Front Panel	3	Before You Start Recording	39
Remote Control	5	Using Automatic Recording Functions	40
Getting Started	6	Recording CDs	43
Unpacking	6	Recording FM/AM Broadcasts	45
Connecting Antennas	6	Recording the External Component	46
Connecting Speakers	7	Making Your Own Titles	48
Connecting Other Equipment	8	Assigning Titles to Albums and Tracks	49
Putting the Batteries into the Remote Control	9	Editing the HDD	51
Basic Settings	10	Introducing HDD Editing Functions	52
Turning On the Power	11	Changing the Library Names—LIB. NAME	53
Setting the Clock	11	Restoring the Libraries—RESTORE	54
Changing the Display Brightness	12	Copying an Album—COPY ALBUM	54
Changing the Display Contrast	12	Moving an Album—LIB. CHANGE	55
Basic and Common Operations	13	Making a New Album—MAKE ALBUM	55
Selecting the Sources and Starting Play	14	Erasing an Album—ERASE	56
Adjusting the Volume	14	Erasing All Albums—ALL ERASE	57
Reinforcing the Bass Sound	15	Copying a Track—COPY TRACK	57
Adjusting the Bass and Treble Sounds	15	Copying a Portion of a Track—A-B COPY	58
Using the AAC Sounds	16	Moving a Track—MOVE	59
Listening to FM and AM Broadcasts	17	Dividing a Track—DIVIDE	60
Tuning in to a Station	18	Joining Tracks—JOIN	61
Presetting Stations	19	Erasing a Track—ERASE TRK	62
Tuning in to a Preset Station	19	Using the Timers	63
Playing Back the External Component	20	Using Recording Timer	64
Selecting the External Component	21	Using Daily Timer	66
Adjusting the Input Level	21	Using Sleep Timer	67
Changing the Source Name	22	Using Auto Power Off	68
Playing Back CDs (CD/CD-R/CD-RW)	23	Timer Priority	68
Precautions on CD Playback	24	Using an Optional Keyboard	69
Playing Back the Entire CD—Normal Play	24	Keys Used for Operating This Unit	69
Basic CD Operations	25	Operating Procedures Using the Keyboard	70
Programing the Playing Order of the Tracks		Maintenance	72
—Program Play	25	Messages	73
Playing at Random—Random Play	26	Troubleshooting	75
Repeating Tracks or CD—Repeat Play	27	Specifications	78
Prohibiting Disc Ejection—Disc Lock	27		
Playing Back the HDD (Hard Disk Drive)	28		
Playing Back the Entire HDD			
—Continuous Play	29		
Basic HDD Operations	30		
Playing Tracks in an Album—Album Play	31		
Playing Albums in a Library—Library Play	32		
Playing at Random—Random Play	33		
Repeating Tracks—Repeat Play	33		
Searching for Albums and Tracks to Play			
—Search Modes	34		

Location of the Buttons

Become familiar with the buttons on your unit.

Front Panel

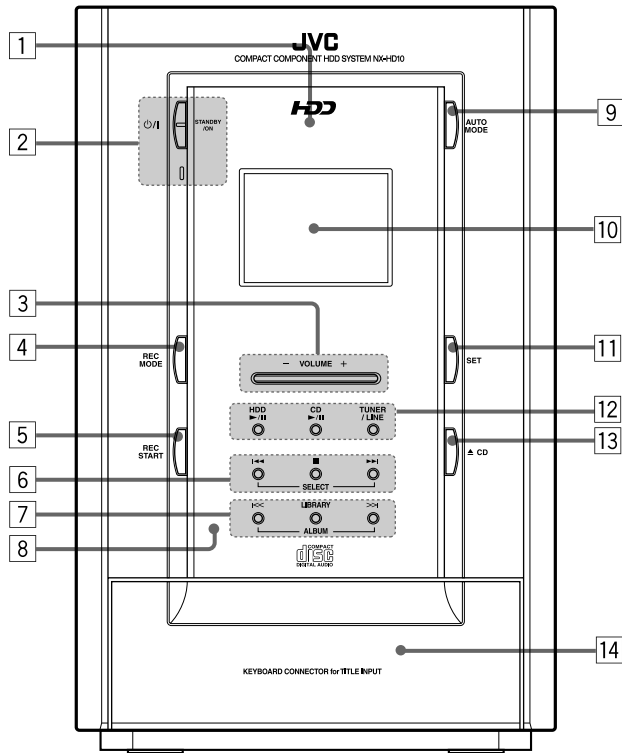

Inside of Front Door

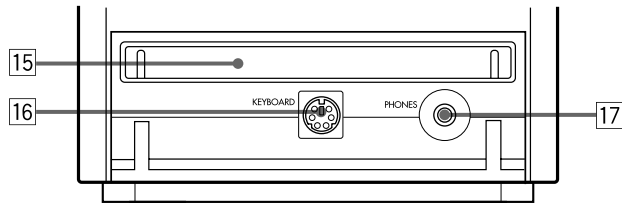

Display Window

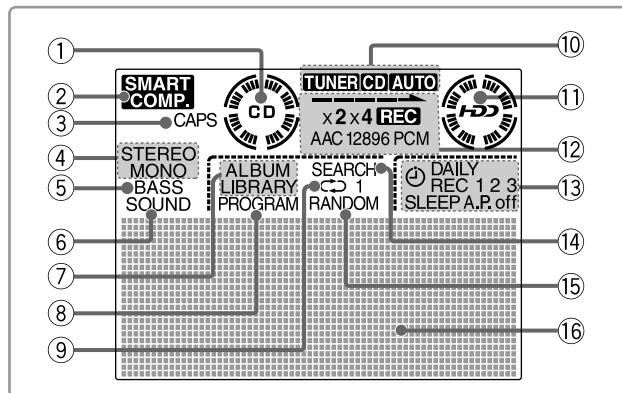

See pages in the parentheses for details.

Front Panel

- 1 HDD lamp (11, 30)
- 2 STANDBY/ON \odot /I button and lamp (11, 40)
- 3 VOLUME + / - button and lamp (14, 15)
- 4 REC MODE button (43, 45, 46)
- 5 REC START button (43 - 47)
- 6 Multi operation buttons
 - SELECT \lll / \ggg , and \blacksquare
- 7 HDD operation buttons
 - LIBRARY and ALBUM \lll / \ggg
- 8 Remote sensor
- 9 AUTO MODE button (40 - 42)
- 10 Display window
- 11 SET button
- 12 Source selection and operation buttons
 - HDD \blacktriangleright / \blacksquare (play/pause) button (14, 29)
 - CD \blacktriangleright / \blacksquare (play/pause) button (14, 24, 43)
 - TUNER/LINE button (14, 18, 21)
 - Pressing one of these buttons also turns on the unit.
- 13 \blacktriangle (eject) CD button (24)
 - Pressing this button also turns on the unit.
- 14 Front door
- 15 CD tray (24)
- 16 KEYBOARD terminal (9)
- 17 PHONES jack (14)

Display Window

- 1 CD indicator (25)
- 2 SMART COMP. indicator (40)
- 3 CAPS indicator
 - Lights up only when the keyboard connected to the KEYBOARD terminal is "caps-locked."
- 4 FM mode indicators (18)
 - STEREO and MONO
- 5 BASS indicator (15)
- 6 SOUND indicator (16)
- 7 HDD operation indicators (31, 32, 34, 35)
 - ALBUM and LIBRARY
- 8 PROGRAM indicator (25)
- 9 Repeat indicators (27, 33)
 - \curvearrowright and \curvearrowleft
- 10 Auto recording indicators (41, 42)
 - TUNER, CD, and AUTO
- 11 HDD indicator (30)
- 12 Recording indicators (43, 45, 46)
 - x2, x4, REC, AAC 128, AAC 96, and PCM
- 13 Clock and timer mode indicators
 - $\text{\textcircled{C}}$ (clock) (11)
 - DAILY, REC 1/2/3, SLEEP, and A.P.off (64 - 68)
- 14 SEARCH indicator (34, 35)
- 15 RANDOM indicator (26, 33)
- 16 Main display
 - Shows the source name, track and/or album number, and other information.

How to open the front door

- 1 Push on the lower part of the door.

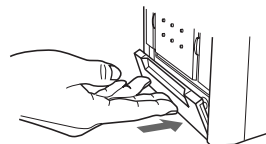

- 2 Pull down the door slowly until it clicks.

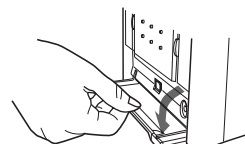

To close the door, push it up slowly.

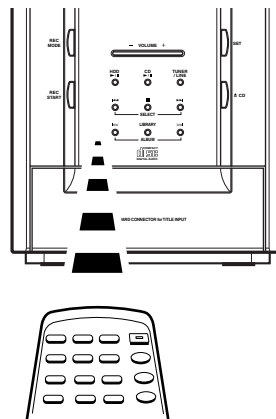
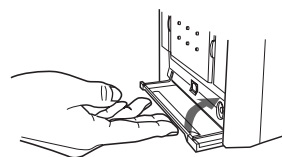

When using the remote control, point it at the remote sensor on the front panel.

- If you point the remote control diagonally at the remote sensor or far from the unit, or if the path in between is blocked, transmitted signals cannot reach the sensor.

Remote Control

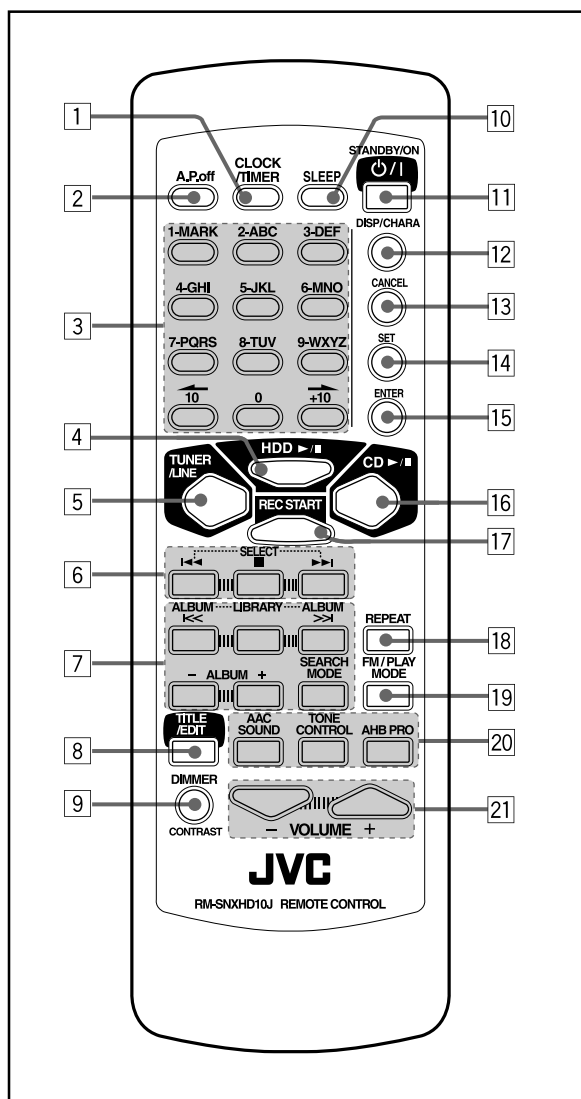

- 1 CLOCK/TIMER button (11, 64 – 67)
- 2 A.P.off button (68)
- 3 Number buttons
 - 0 – 10, +10 buttons (19, 25, 34)
 - Character entry buttons (A – Z, 0 – 9) (35, 49)
 - ◀ (10), ▶ (+10) buttons (35, 49)
 - MARK button (35, 49)
- 4 HDD ▶/⏸ (play/pause) button (14, 29, 50)
 - Pressing this button also turns on the unit.
- 5 TUNER/LINE button (14, 18, 21)
 - Pressing this button also turns on the unit.
- 6 Multi operation buttons
 - SELECT ◀◀◀ / ▶▶▶, and ■
- 7 HDD operation buttons (31)
 - ALBUM ◀◀ / >>, LIBRARY, ALBUM + / –, and SEARCH MODE
- 8 TITLE/EDIT button (49, 50, 53 – 62)
- 9 DIMMER button (12)
CONTRAST button (12)
- 10 SLEEP button (67)
- 11 STANDBY/ON ⏻/⏻ button (11, 40, 65, 67)
- 12 DISP/CHARA button (18, 21, 25, 30, 41, 43, 44, 46, 47)
- 13 CANCEL button
- 14 SET button
- 15 ENTER button
- 16 CD ▶/⏸ (play/pause) button (14, 24, 43)
 - Pressing this button also turns on the unit.
- 17 REC START button (43 – 47)
- 18 REPEAT button (27, 33)
- 19 FM/PLAY MODE button (18, 25, 26, 31, 32)
- 20 Sound control buttons (15, 16)
 - AAC SOUND, TONE CONTROL, and AHB PRO
- 21 VOLUME + / – buttons (14, 15)

Unpacking

After unpacking, check to be sure that you have all the following items.

The number in the parentheses indicates the quantity of the pieces supplied.

- FM antenna (1)
- AM loop antenna (1)
- Remote control (1)
- Batteries (2)
- AC power cord (1)
- Speaker cords (2)

If any is missing, consult your dealer immediately.

Connecting Antennas

FM antenna

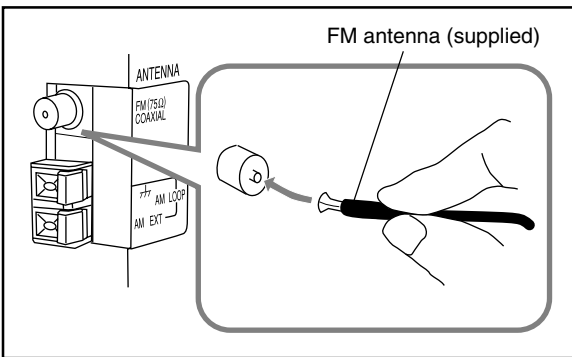

- 1** Attach the FM antenna to the FM (75 Ω) COAXIAL terminal.
- 2** Extend the FM antenna.
- 3** Fasten it up in the position which gives you the best reception.



About the supplied FM antenna

The FM antenna supplied with this unit can be used as temporary measure. If reception is poor, you can connect an outdoor FM antenna.

To connect an outdoor FM antenna

Before connecting it, disconnect the supplied FM antenna.

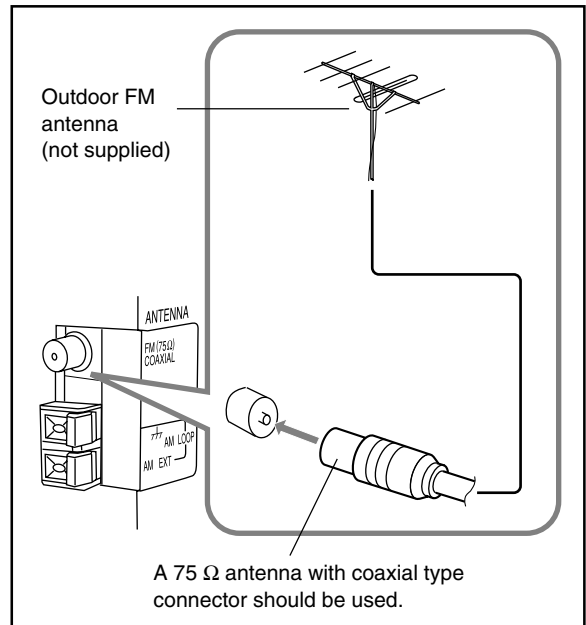

AM antenna

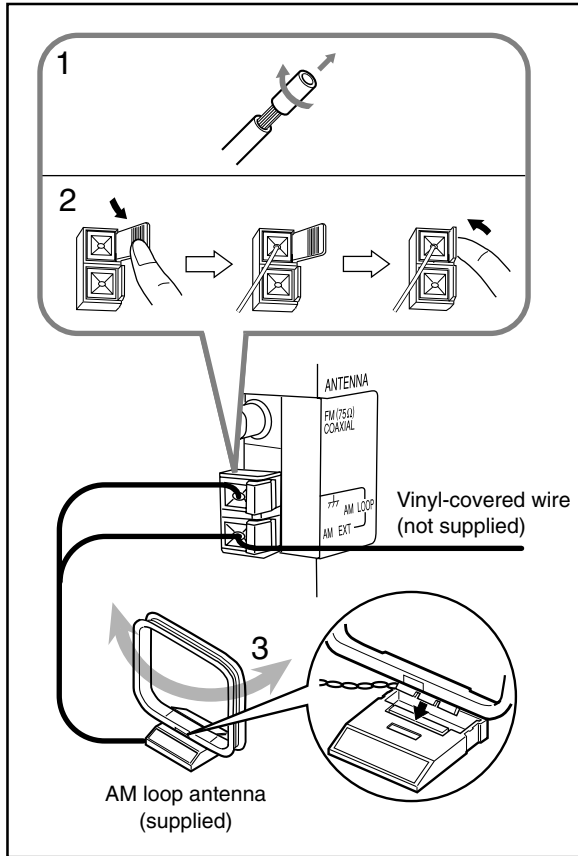

- 1** If cords are covered with insulation, twist the core of the cord at the end of each cord, then remove the insulation.
- 2** Connect the AM loop antenna to the AM LOOP terminals as illustrated.
- 3** Turn the AM loop antenna until you have the best reception.

To connect an outdoor AM antenna

When reception is poor, connect a single vinyl-covered wire to the AM EXT terminal and extend it horizontally. (The AM loop antenna must remain connected.)



For better reception of both FM and AM

- Make sure the antenna conductors do not touch any other terminals and connecting cords.
- Keep the antennas away from metallic parts of the unit, connecting cords, and the AC power cord.

Connecting Speakers

You can connect the speakers using the speaker cords.

Use only speakers with the same speaker impedance—more than $4\ \Omega$ —as indicated by the speaker terminals on the rear of the unit.

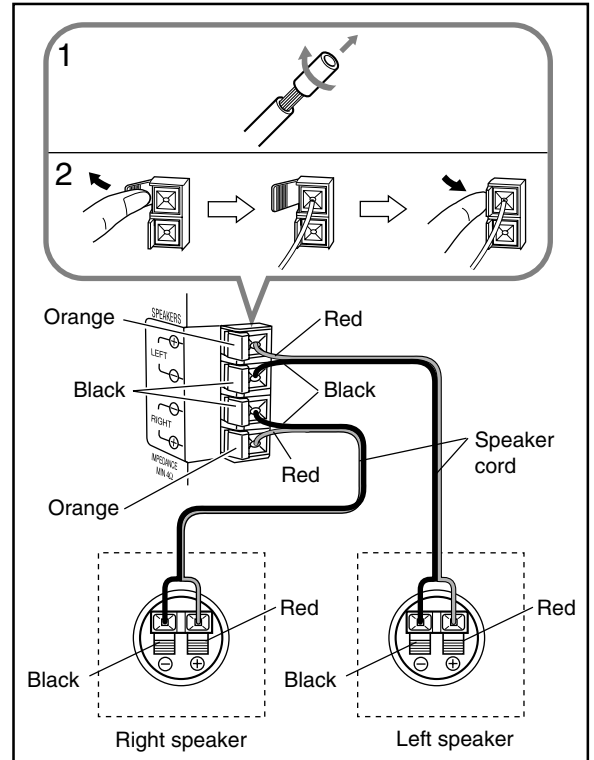

- 1** If cords are covered with insulation, twist the core of the cord at the end of each cord, then remove the insulation.
- 2** Insert the end of the speaker cord into the terminal as illustrated.

Match the polarity of the speaker terminals: (+) to (+) and (-) to (-).



- DO NOT connect or disconnect the speakers while the unit is turned on.
- DO NOT connect more than one speaker to one speaker terminal.

To remove the speaker grille

The speaker grilles are removable as shown below:

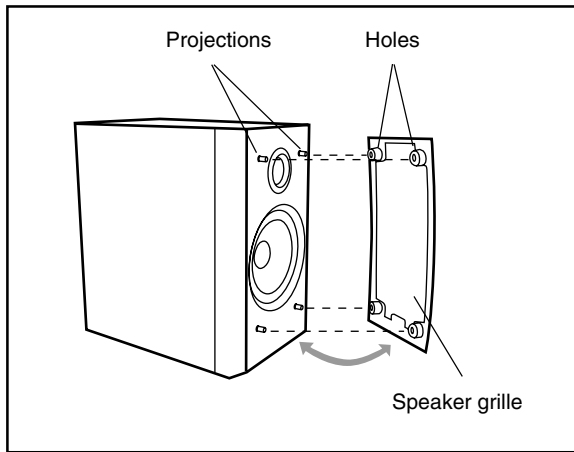

To remove the speaker grille, insert your fingers at the top of the speaker grille, then pull towards you. Do the same at the bottom.

To attach the speaker grille, put the projections of the speaker into the holes of the speaker grille.

Connecting Other Equipment

You can connect a cassette deck, etc.—used as a playback and recording device.

When you connect the other equipment, refer also to the manuals supplied with it.



- DO NOT connect other equipment while the power is on.
- DO NOT plug in any equipment until all connections are complete.

Be sure that the plugs of the audio cords and the jacks on the rear of the unit are color coded: White plugs and jacks are for left audio signals, and red ones for right audio signals.

Ex. When connecting a cassette deck

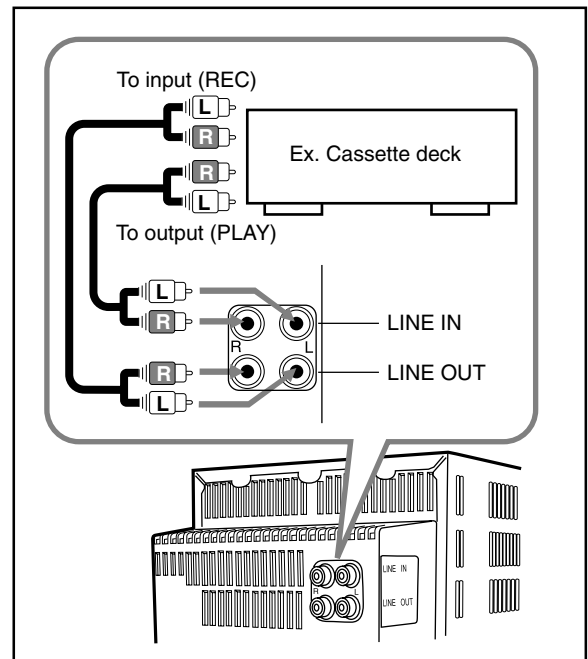

By using audio cords (not supplied), connect:

- Between the audio input jacks on the cassette deck and the LINE OUT jacks—For recording on the cassette deck.
- Between the audio output jacks on the cassette deck and the LINE IN jacks—For playing a tape.

NOW, you can plug in the unit and other connected equipment FINALLY!

IMPORTANT: Be sure to check all connections to be done before plugging the AC power cord into a wall outlet.

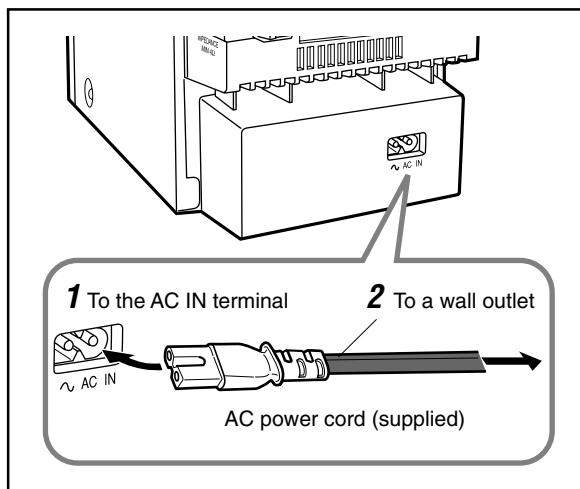

Connecting a keyboard

You can connect a PC-compatible keyboard (with the PS/2 plug) to the KEYBOARD terminal inside the front door.

By connecting a keyboard, you can easily enter library names, album titles, and track titles. You can also use the keyboard for Search Modes.

- See “Using an Optional Keyboard” on page 69.

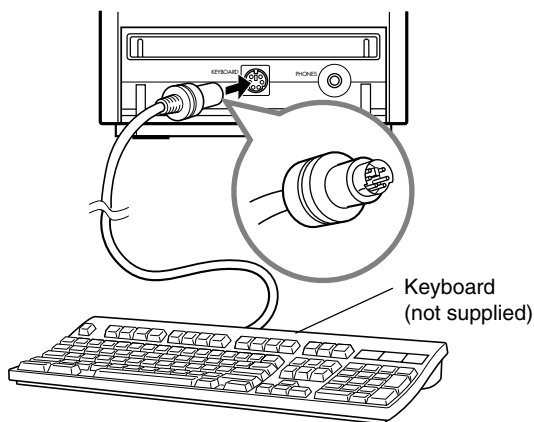

- Before connecting, observe the shape of the plug and of the terminal to match them correctly.
- Before connecting or disconnecting the keyboard, make sure to turn off the unit.

Putting the Batteries into the Remote Control

Insert the batteries—R6P(SUM-3)/AA(15F)—into the remote control, by matching the polarity (+ and –) on the batteries with the + and – markings on the battery compartment.

When the remote control can no longer operate the unit, replace both batteries at the same time.

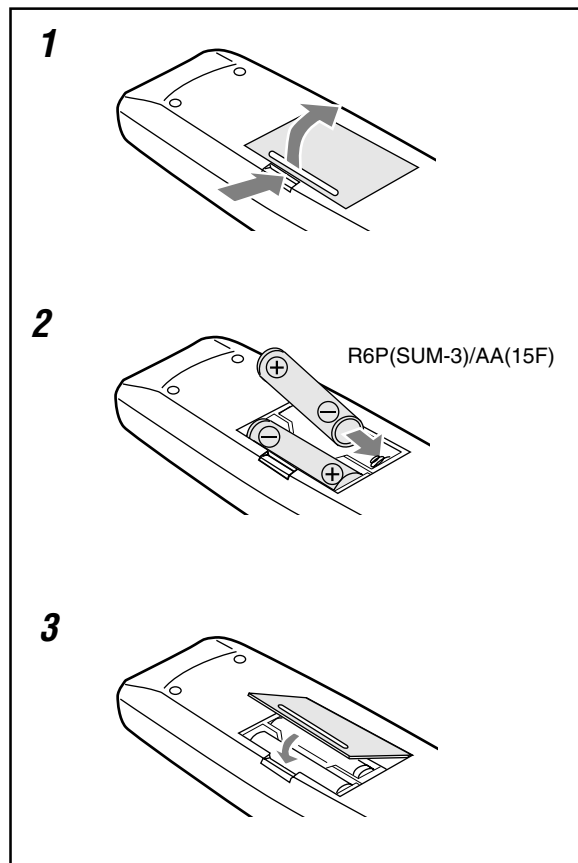

- DO NOT use an old battery together with a new one.
- DO NOT use different types of batteries together.
- DO NOT expose batteries to heat or flame.
- DO NOT leave the batteries in the battery compartment when you are not going to use the remote control for an extended period of time. Otherwise, it will be damaged from battery leakage.

Basic Settings

The buttons enlarged in the illustration below are used and explained in this section (pages 11 and 12).

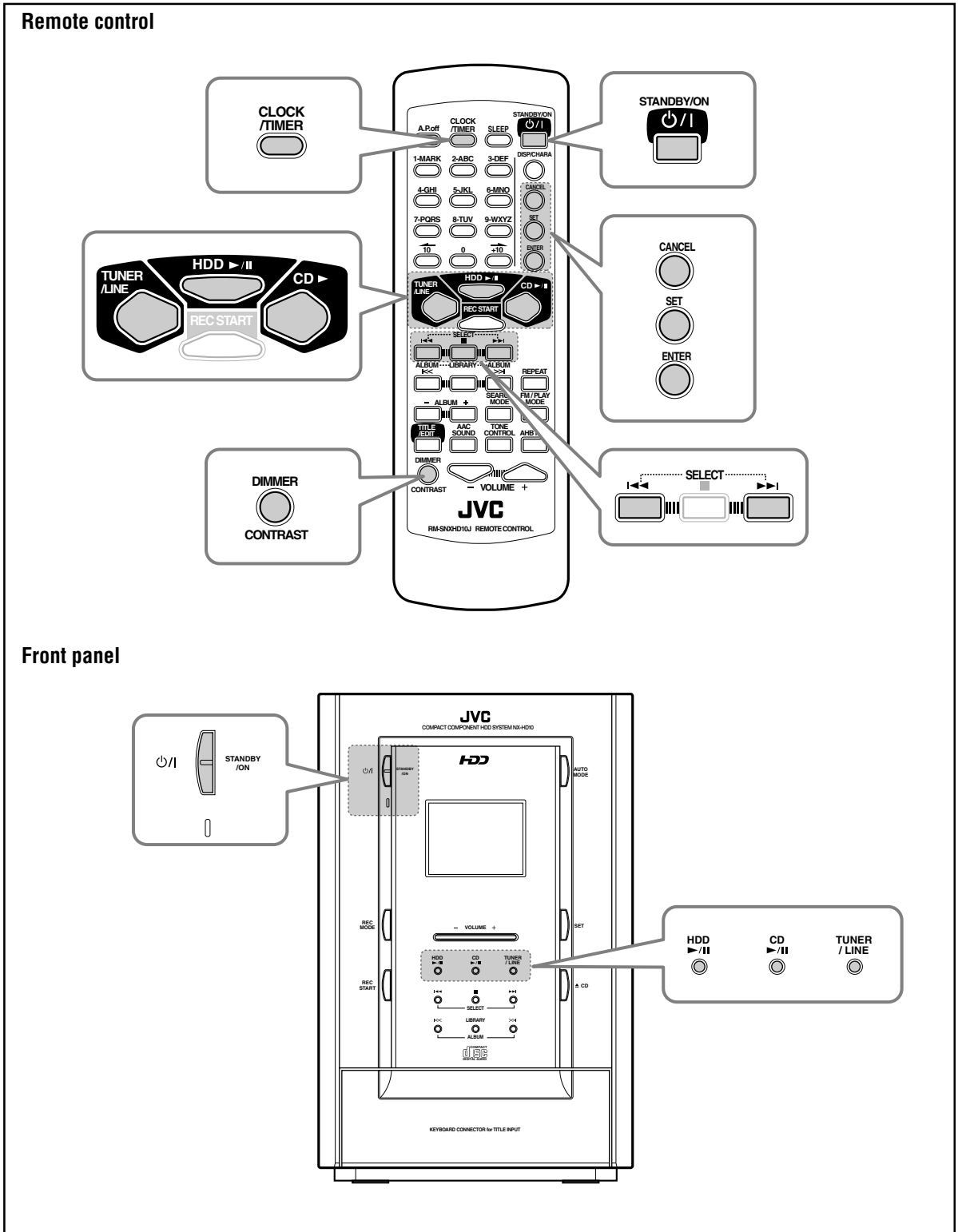

Before operating the unit any further, first set the clock built in this unit, then some other basic settings.

Turning On the Power

When you press one of the source selecting buttons—HDD ►/II, CD ►/II, TUNER/LINE, the unit automatically turns on (and starts playback if the source is ready).

To turn on the unit without playing, press STANDBY/ON ○/I so that the STANDBY/ON lamp on the unit lights in green.

HELLO

- The HDD lamp flashes then lights in blue. The VOLUME lamp also lights in blue. While the HDD lamp is flashing, no remote control operations are accepted. For detailed information on the HDD lamp, see page 30. (See also “Changing the Display Brightness” on the next page.)
- The ⌚ indicator starts flashing if the built-in clock is not set. (It lights if the clock is already set.)

To turn off the unit (on standby), press STANDBY/ON ○/I again so that the STANDBY/ON lamp lights in red.

SEE YOU

If Smart Compression has been turned “ON” (see page 40), it starts working and the STANDBY/ON lamp flashes in green while Smart Compression is performed. Then the unit will turn off (on standby).

A little power is always consumed even while the unit is in standby mode.

To switch off the power supply completely, unplug the AC power cord from the AC outlet.



DO NOT unplug the AC power cord in the following cases; otherwise, the data in the HDD may be damaged:

- While recording or editing.
- While Smart Compression is working.



When you unplug the AC power cord or if a power failure occurs

The clock is reset to “Monday AM12:00” after about a minute, while the tuner preset stations and other settings will be erased in a few days.

Setting the Clock

You can set the clock whether the unit is turned on or in standby mode.

On the remote control ONLY:

- 1 Press CLOCK/TIMER.
The day of the week starts flashing in the main display.

Monday
OK?→SET

- 2 Press SELECT ►► or SELECT ◀◀ to select the correct day of the week, then press SET.

- When you press and hold SELECT ►► or SELECT ◀◀, the day of the week changes continuously.

AM 12:00
OK?→SET

The hour digit in the main display starts flashing.

- 3 Press SELECT ►► or SELECT ◀◀ to adjust the hour, then press SET.

- When you press and hold SELECT ►► or SELECT ◀◀, the hour digit changes continuously.

PM 2:00
OK?→SET

The minute digits start flashing.

- If you want to correct the hour after pressing SET, press CANCEL. The hour digit starts flashing again.

- 4 Press SELECT ►► or SELECT ◀◀ to adjust the minute, then press SET.

- When you press and hold SELECT ►► or SELECT ◀◀, the minute digit changes continuously.

ADJUST OK

“ADJUST OK” appears in the main display, and the built-in clock starts.

To adjust the clock again

Once you have adjusted the clock, you need to press **CLOCK/TIMER** repeatedly until the clock setting screen appears in the main display (until the day of the week starts flashing), then follow steps **2** to **4** on the previous page.

To turn on/off the clock indication

You can turn on the clock indication on the display while the unit is in standby mode.

Press **DIMMER (CONTRAST)** on the remote control while the unit is in standby mode.

The clock indication appears on the display.

To turn off the clock indication for saving the power, press **DIMMER (CONTRAST)** again while the unit is in standby mode.

Changing the Display Brightness

You can change the display brightness while the unit is turned on.

On the remote control ONLY:

Press **DIMMER (CONTRAST)**.

The display illumination dims, and the **HDD** and **VOLUME** lamps go off—dimmer.

- Each time you press the button, the display brightness alternates between normal mode and dimmer mode.

IMPORTANT: Operating procedures through the entire manual are explained assuming that dimmer mode is not activated (initial setting when shipped from the factory).

Changing the Display Contrast

You can change the display contrast while the unit is turned on.

On the remote control ONLY:

- 1 Press and hold CONTRAST (DIMMER) for more than 2 seconds.**

“CONTRAST” and the current setting appear in the main display.

The display shows the word "CONTRAST" in a large, pixelated font. Below it is a horizontal bar with a small black segment on the left. To the right of the bar is the number "+4".

- 2 Press SELECT ►► or SELECT ◄◄ to adjust the contrast.**

- You can adjust the contrast within the range of 0 to +7.

The display shows the word "CONTRAST" in a large, pixelated font. Below it is a horizontal bar with a small black segment on the left. To the right of the bar is the number "+7".

- 3 Press SET or ENTER to finish setting.**

- If you do not press the button for about 60 seconds, the setting will be stored, then the source indication will be resumed.

Basic and Common Operations

The buttons enlarged in the illustration below are used and explained in this section (pages 14 and 16).

Remote control

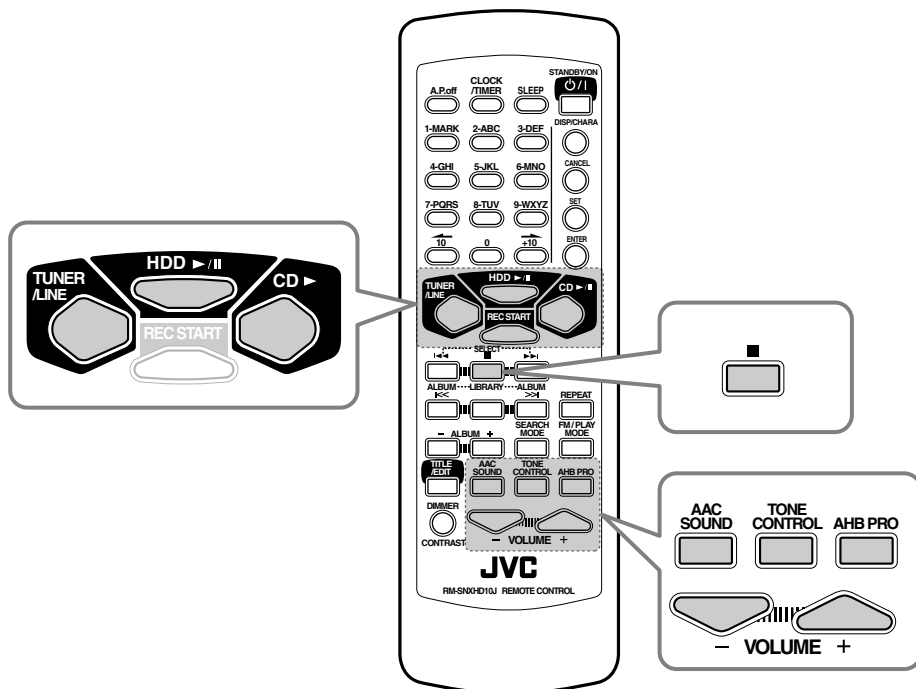

Front panel

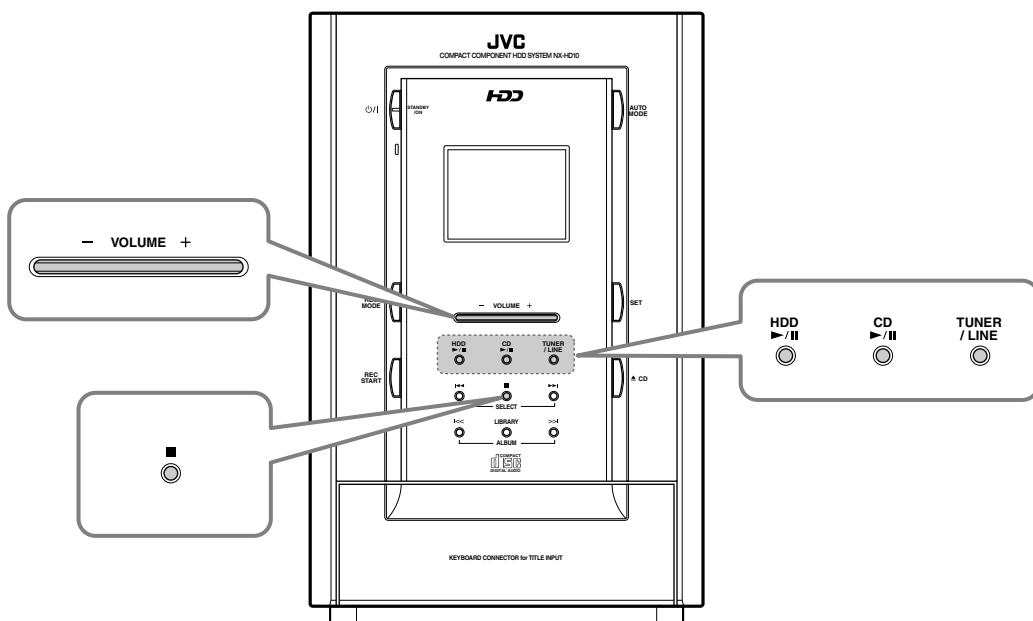

Selecting the Sources and Starting Play

To select **FM**, **AM** or external component as the source, press **TUNER/LINE** repeatedly until “FM,” “AM” or “LINE*” is selected.

- If the unit is in standby mode, the power automatically comes on at the first press of the button.
- Each time you press the button, the source changes as follows:

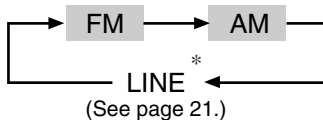

- FM** : To tune in to the last received FM station.
AM : To tune in to the last received AM station.
LINE* : To use the external equipment connected to the LINE IN terminal.

* If you have changed the source name of the external component, the currently selected source name will appear (see page 22).

- For more detailed tuner operations, see pages 17 to 19.
- For operating the external equipment, see pages 20 to 22.

To select the **CD player** as the source, press **CD ►/II**.

When the unit is in standby mode:

The unit automatically turns on.

When the unit is turned on:

“CD PLAY” appears in the main display for a while.

- Playback will start if a CD is on the CD tray.
- “CD NO DISC” will appear in the main display if a CD is not loaded.

To stop playback, press **■**.

- For more detailed operations, see pages 23 to 27.

To select the **HDD (hard disk drive)** as the source, press **HDD ►/II**.

When the unit is in standby mode:

The unit automatically turns on.

When the unit is turned on:

“HDD PLAY” appears in the main display for a while.

- “HDD NO DATA” will appear in the main display if nothing is recorded. (To record into the HDD, see pages 38 to 47.)

To stop playback, press **■**.

- For more detailed operations, see pages 28 to 37.

Adjusting the Volume

You can adjust the volume level only while the unit is turned on.

To increase the volume, press **VOLUME +**.

To decrease the volume, press **VOLUME -**.



- You can adjust the volume within the range of 0 (silence) to 50 (maximum).
- When you press and hold the button, the volume level keeps changing.



For private listening

Connect a pair of headphones to the PHONES jack inside the front door. No sound comes out of the speakers. Be sure to turn down the volume before connecting or putting on the headphones.



If “CANNOT LISTEN!” appears in the main display

During high-speed recording (PCM x2 REC, PCM x4 REC) (see page 43), you cannot listen to any source, and therefore, cannot adjust the volume level.



DO NOT turn off (in standby mode) the unit with the volume set to an extremely high level; otherwise, the sudden blast of sound can damage your hearing, speakers and/or headphones when you turn on the unit or start playing any source.
REMEMBER you cannot adjust the volume level while the unit is in standby mode.

Reinforcing the Bass Sound

The richness and fullness of the bass sound is clearly maintained regardless of how low you set the volume —Active Hyper Bass Pro.

- You can use this effect only for playback.
- This function also affects the sound from headphones.

On the remote control ONLY:

To get the effect, press AHB PRO repeatedly until “AHB 1” or “AHB 2” appears in the main display. The BASS indicator lights up on the display.

- Each time you press the button, the Active Hyper Bass Pro mode changes as follows:

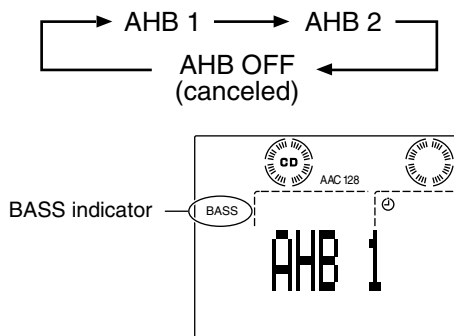

Ex. When “AHB1” is selected

- “AHB 2” is more effective than “AHB 1.”

To check the effect level, press AHB PRO once.

To cancel the effect, press AHB PRO repeatedly until “AHB OFF” appears in the main display. The BASS indicator goes off from the display.

Adjusting the Bass and Treble Sounds

You can adjust bass and treble sounds to your taste and surroundings.

- You can use this effect only for playback.
- This function also affects the sound from headphones.

On the remote control ONLY:

1 Press TONE CONTROL to select “BASS” or “TREBLE.”

The selected tone control mode and the current setting appear in the main display.

The display shows "BASS 0" and "ADJUST VOL." in a digital font.

- Each time you press the button, the tone control mode changes as follows:

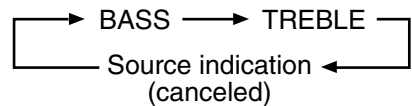

2 Press VOLUME + or VOLUME - to adjust the selected tone level.

- You can adjust the tone level within the range of -5 to +5.

The display shows "BASS +3" and "ADJUST VOL." in a digital font.

Ex. “BASS” level is set to “+3”

3 Repeat steps 1 and 2 to adjust the other tone level.

4 Press TONE CONTROL to finish the setting.

- If you do not press the button for about 5 seconds, the setting will be stored, then the source indication will be resumed.

To check the current level, press TONE CONTROL repeatedly.

Using the AAC Sounds

You can apply special sound modes to the tracks recorded in the AAC (Advanced Audio Coding: see the right column) format.

- You can use this effect only for playback of the AAC encoded tracks.
- This function also affects the sounds through the PHONES jack and the LINE OUT jacks.
- To record into the HDD using the AAC format, see pages 38 to 47.

On the remote control ONLY:

To activate the AAC sound modes, press AAC SOUND repeatedly until an AAC sound mode you want appears in the main display.

The SOUND indicator lights up on the display.

- Each time you press the button, AAC sound modes change as follows:

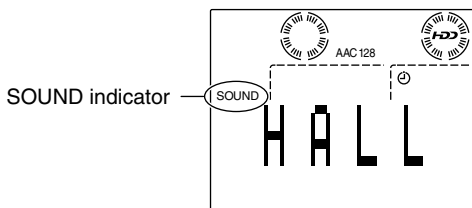
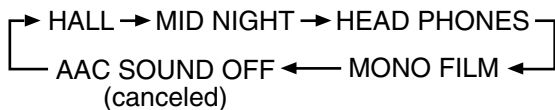

Ex. When "HALL" is selected

- HALL** : Use this when you want to add depth and brilliance to the sounds.
- MID NIGHT** : Use this when listening at night. A powerful sound will be maintained even at a low volume level.
- HEAD PHONES** : Use this when listening with the headphones. Spatial and stereophonic feelings will be maintained.
- MONO FILM** : Use this to listen to a monaural source. Stereophonic feeling will be created.
- AAC SOUND OFF** : AAC sound mode is canceled.

To check the current AAC sound mode, press AAC SOUND once.

To cancel the AAC sound modes, press AAC SOUND repeatedly until "AAC SOUND OFF" appears in the main display.

The SOUND indicator goes off from the display.



If "NOT AAC" appears in the main display

While playing a non-AAC track, you cannot use any AAC sound mode.

What is AAC?

AAC, licensed by Dolby Laboratories, is high-quality sound encoding technology, enabling us to compress sounds without losing the brilliance of the original. AAC can eliminate over 90 percent of the original signal data without noticeable sound quality deterioration.

Even compared to MP3 technology, AAC can provide higher-quality sound reproduction, with about 30 percent less data volume.

Licensed AAC Patents (U.S. patent numbers)

Pat. 5,848,391;	5,291,557;	5,451,954;
5 400 433;	5,222,189;	5,357,594;
5 752 225;	5,394,473;	5,583,962;
5,274,740;	5,633,981;	5 297 236;
4,914,701;	5,235,671;	07/640,550;
5,579,430;	08/678,666;	98/03037;
97/02875;	97/02874;	98/03036;
5,227,788;	5,285,498;	5,481,614;
5,592,584;	5,781,888;	08/039,478;
08/211,547;	5,703,999;	08/557,046;
08/894,844;	5,299,238;	5,299,239;
5,299,240;	5,197,087;	5,490,170;
5,264,846;	5,268,685;	5,375,189;
5,581,654;	5,548,574;	5,717,821

Listening to FM and AM Broadcasts

The buttons enlarged in the illustration below are used and explained in this section (pages 18 and 19).

Remote control

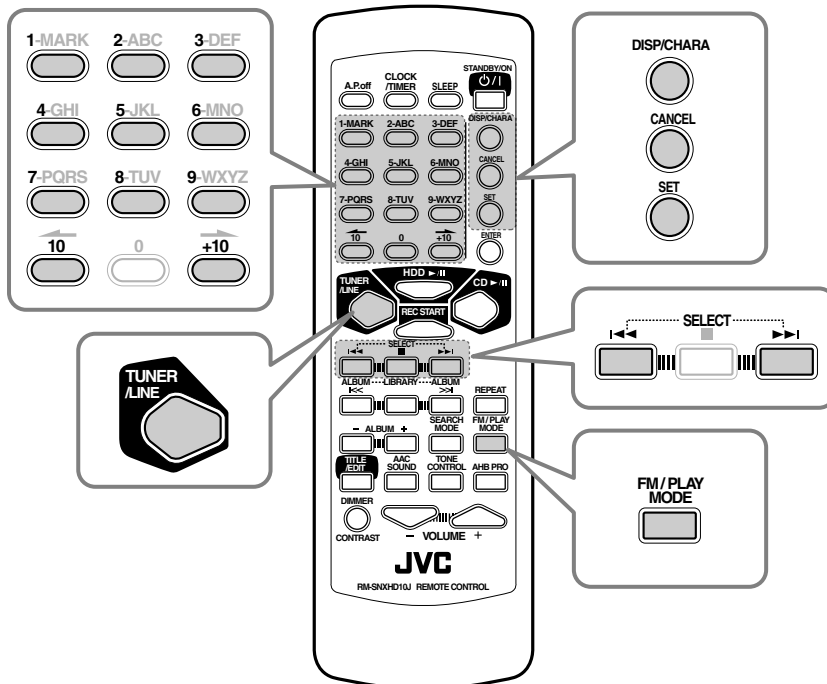

Front panel

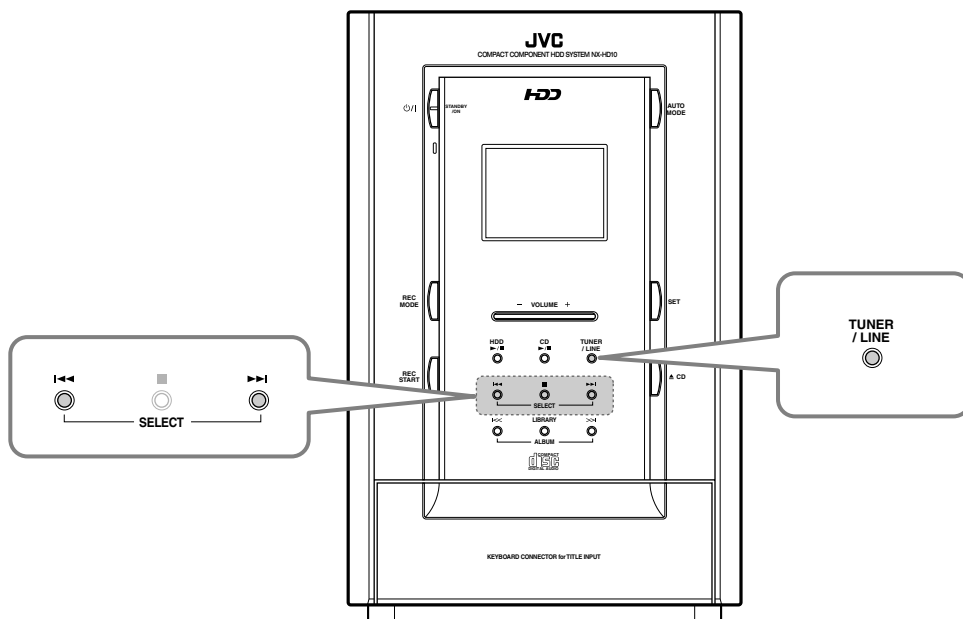

Tuning in to a Station

- 1** Press TUNER/LINE repeatedly until “FM” or “AM” is selected.

The unit automatically turns on and tunes in to the previously received station.

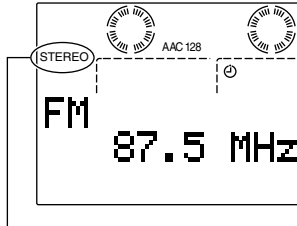

If an FM program is broadcast in stereo, the STEREO indicator lights up.

- Each time you press the button, the source changes as follows:

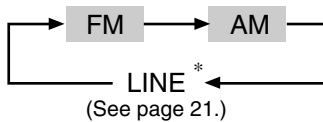

- * If you have changed the source name of the external component, the currently selected source name will appear (see page 22).

- 2** Press and hold SELECT ►► or SELECT ◄◄ until the station frequencies start changing in the main display.

- SELECT ►► : to increase the frequencies.
- SELECT ◄◄ : to decrease the frequencies.

The unit starts searching for stations and stops when a station of sufficient signal strength is tuned in.

FM
95.1 MHz

To stop during searching, press SELECT ►► or SELECT ◄◄.



When you repeatedly press SELECT ►► or SELECT ◄◄

The frequency changes step by step.

To change the FM reception mode

When an FM stereo broadcast is noisy or hard to receive, you can change the FM reception mode to improve the reception.

Press FM/PLAY MODE on the remote control.

- Each time you press the button, FM reception mode alternates between “FM MONO” and “FM AUTO.”

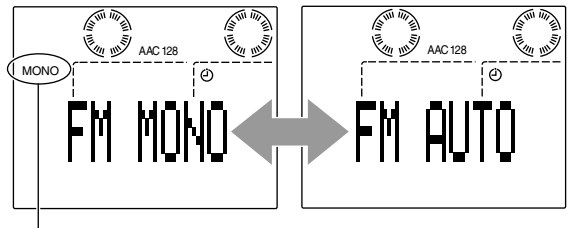

MONO indicator

FM MONO : Select this when an FM stereo broadcast is noisy or hard to receive. Reception improves though stereo effect is lost. The MONO indicator lights up on the display.

FM AUTO : Normally select this. In this mode, you can hear stereo sound when a program is broadcast in stereo.

To change the information shown in the main display

Each time you press DISP/CHARA on the remote control, the information in the main display changes as follows:

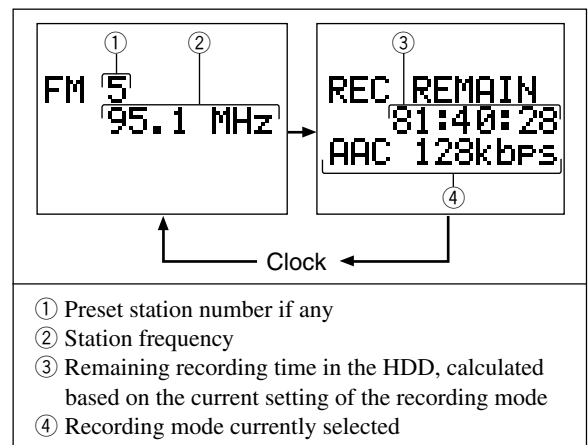

Presetting Stations

You can preset 30 FM and 15 AM stations manually following the procedure below.

In some cases, test frequencies have been already memorized for the tuner since the factory examined the tuner preset function before shipment. This is not a malfunction. You can preset the stations you want into memory by following the presetting method.

- There is a time limit in doing the following steps. If the setting is canceled before you finish, start from step 2 again.

On the remote control ONLY:

- 1 Tune in to the station you want to preset.**
 - See “Tuning in to a Station” on page 18.

- 2 Press SET.**

The preset number 1 starts flashing.

```

FM 1
  95.1 MHz
STORE?→SET
  
```

- To cancel the presetting, press CANCEL.

- 3 Press the number buttons to select a preset number.**

Ex. For preset number 5, press 5.

For preset number 15, press +10, then 5.

For preset number 20, press +10, then 10.

```

FM 5
  95.1 MHz
STORE?→SET
  
```

- 4 Press SET again.**

```

FM 5
  95.1 MHz
STORED
  
```

“STORED” appears in the main display.

The tuned station in step 1 is stored in the preset number selected in step 3.

- Storing a new station on a used number erases the previously stored one.



When you unplug the AC power cord or if a power failure occurs

The preset stations will be erased in a few days. If this happens, preset the stations again.

Tuning in to a Preset Station

On the remote control ONLY:

- 1 Press TUNER/LINE repeatedly until “FM” or “AM” is selected.**

The unit automatically turns on and tunes in to the previously received station.

```

FM
  91.5 MHz
  
```

- Each time you press the button, the source changes as follows:

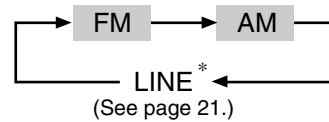

- * If you have changed the source name of the external component, the currently selected source name will appear (see page 22).

- 2 Press the number buttons to select a preset number.**

Ex. For preset number 5, press 5.

For preset number 15, press +10, then 5.

For preset number 20, press +10, then 10.

```

FM 5
  95.1 MHz
  
```

Ex. When number 5 is selected

To record a broadcast program automatically

The unit is provided with Tuner Auto Recording to automatically record any tuned station's program for about 30 minutes.

Selecting any station automatically starts recording into the HDD without any setting.

- For more details on Tuner Auto Recording, see page 42.

Playing Back the External Component

The buttons enlarged in the illustration below are used and explained in this section (pages 21 and 22).

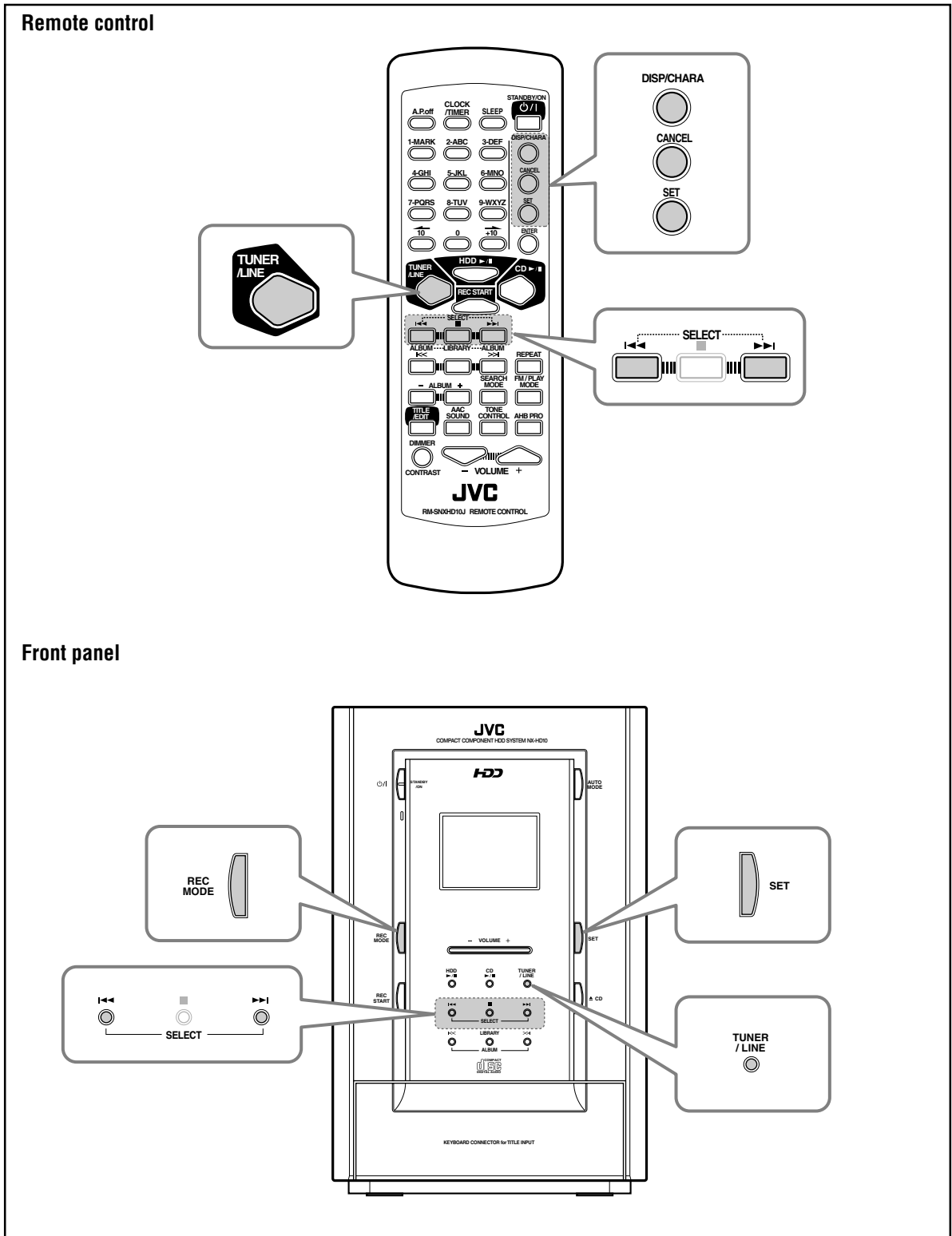

Selecting the External Component

- 1 Press **TUNER/LINE** repeatedly until “**LINE***” (external component) is selected.

The unit automatically turns on.

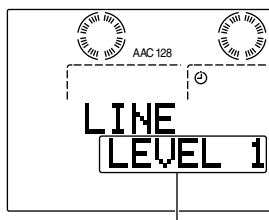

The current input level (see the right column) appears for a while.

- * If you have changed the source name of the external component, the currently selected source name will appear (see page 22).
- Each time you press the button, the source changes as follows:

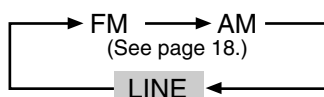

- 2 Start playback on the external component.

- For operating the external equipment, see its supplied manual.

To change the information shown in the main display

Each time you press **DISP/CHARA** on the remote control, the information in the main display changes as follows:

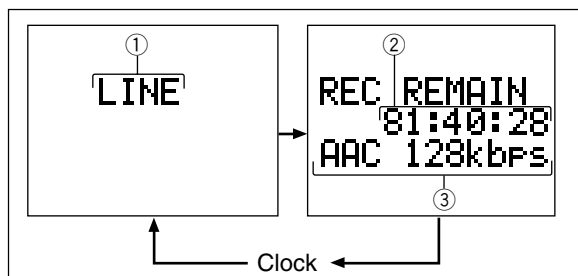

- ① Currently selected source name for the external component—LINE, TAPE, DBS, VCR, TV, or GAME (see page 22)
- ② Remaining recording time in the HDD, calculated based on the current setting of the recording mode
- ③ Recording mode currently selected

Adjusting the Input Level

If the sound from the component connected to the **LINE IN** jacks is too loud or is not loud enough when changing the source to the external component (without adjusting the volume level), you can change the input level through the **LINE IN** jacks.

On the unit ONLY:

- 1 When the source is “**LINE***,” press and hold **REC MODE**.

LINE INPUT
LEVEL 1
OK?→SET

- * If you have changed the source name of the external component, the currently selected source name will appear (see page 22).

- 2 Press **SELECT** **▶▶** or **SELECT** **◀◀** to select an appropriate input level.

- Each time you press the button, the input level alternates between “**LEVEL 1**” and “**LEVEL 2**.”

LINE INPUT
LEVEL 2
OK?→SET

LEVEL 1: Select this when the sound is not loud enough.

LEVEL 2: Select this when the sound is too loud.

- 3 Press **SET** to finish the adjustment.

LINE INPUT
LEVEL 2
STORED

“**STORED**” appears in the main display.

The selected input level will be kept in memory until you change it.



notes If “**Level OVER!**” appears in the main display during play

The input level is too high. Select “**LEVEL 2**” if the current level is “**LEVEL 1**.”

- If the current level is “**LEVEL 2**,” adjust the output level on the external component.
- “**Level OVER!**” will not appear if the “**REC REMAIN**” time or the clock is shown in the main display.

Changing the Source Name

You can change the source name of the external component according to the one connected to the unit.

- You cannot change the source names while recording.

On the remote control ONLY:

- 1** When the source is “LINE*,” press and hold TUNER/LINE until “NAME CHANGE” appears in the main display.

```

NAME CHANGE
>LINE<
OK?→SET
  
```

- * If you have changed the source name of the external component, the currently selected source name will appear.

- 2** Press SELECT ►► or SELECT ◄◄ to select an appropriate source name.

- Each time you press the button, the source name changes as follows:

```

LINE ⇄ TAPE ⇄ DBS ⇄ VCR ⇄ TV ⇄
GAME ⇄ (back to the beginning)
  
```

```

NAME CHANGE
>TAPE<
OK?→SET
  
```

Ex. When selecting “TAPE”

- To cancel the setting, press CANCEL.

- 3** Press SET to finish changing the source name.
The selected source name appears in the main display.

Playing Back CDs (CD/CD-R/CD-RW)

The buttons enlarged in the illustration below are used and explained in this section (pages 24 to 27).

Remote control

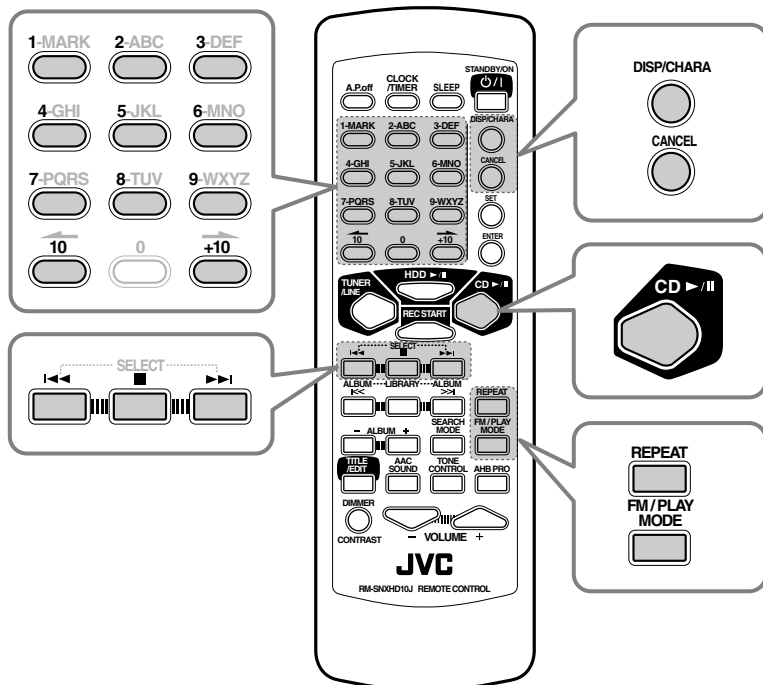

Front panel

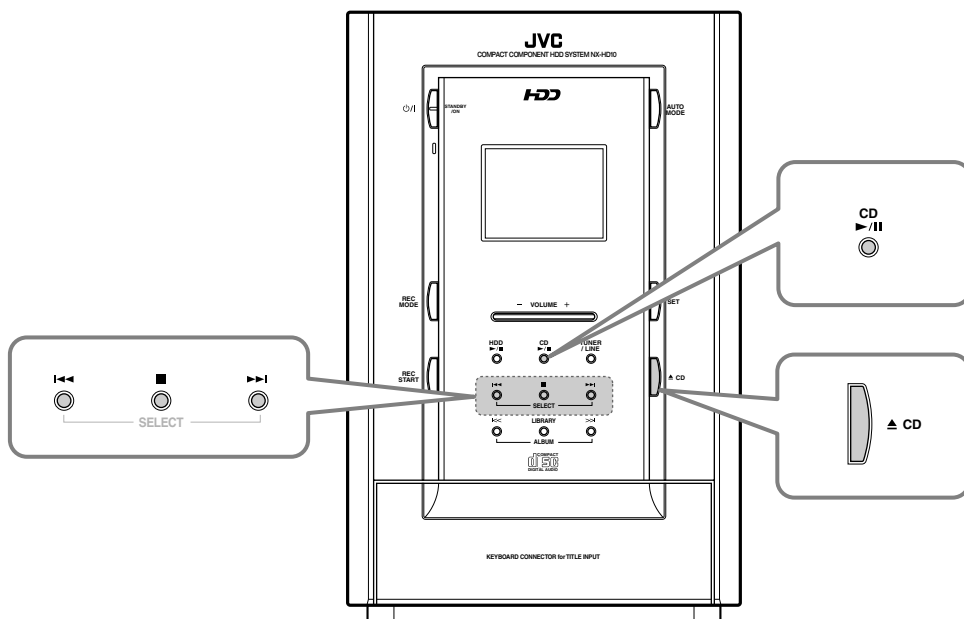

Precautions on CD Playback

This unit has been designed to play back discs bearing the following logo:



Audio CD (CD-DA)

In addition to the above discs, this unit can play back audio data recorded on CD Text, CD-G (CD Graphics), and CD-Extra.

The manufacturer assumes no responsibility for the operation or sound quality of discs that may be incompatible with the CD Standard (CD-DA).

Before playing a disc, confirm whether it is compatible or not by:

- Checking whether the compact disc logo () is printed on the disc itself.
- Reading the instructions or the note printed on the disc package.

When playing a CD-R or CD-RW

User-edited CD-Rs (CD Recordable) and CD-RWs (CD ReWritable) can be played back normally when they are already “**finalized**.” If you play back **unfinalized** CDs, “UNFINALIZE” appears in the main display.

- You can play back your original CD-Rs or CD-RWs recorded in **music CD format ONLY**. (If CD-RWs have been recorded in different format, erase all the data on CD-RWs completely before re-recording on the discs.)



DO NOT play back CD-Rs or CD-RWs including the sound files such as MP3.

- Before playing back CD-Rs or CD-RWs, read their instructions or cautions carefully.
- Some CD-Rs or CD-RWs may not be played back on this unit because of their disc characteristics, damage or stain on them, or if the player’s lens is dirty.

Important notices:

- In general, you will have the best performance by keeping your CDs and the mechanism clean.
 - Store CDs in their cases, and keep them in cabinets or on shelves.
 - Keep the unit’s CD tray closed when not in use.
- Continuous use of irregular shaped discs (heart-shape, octagonal, etc.) can damage the disc rotating mechanism.



- CD-RWs may require a longer readout time since the reflectance of CD-RWs is lower than for regular CDs.

Playing Back the Entire CD—Normal Play

1 Press CD on the unit.

The unit automatically turns on and the CD tray comes out.

- When the source is CD, “CD OPEN” appears in the main display.

2 Place a CD correctly on the circle of the CD tray, with its label side up.

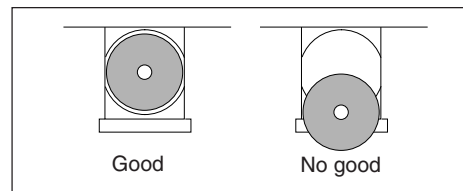
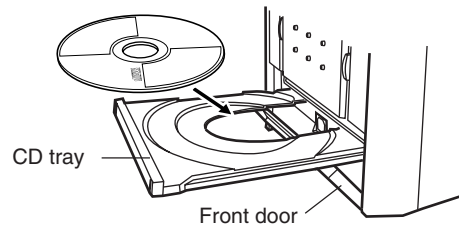

- When using a CD single (8 cm), place it on the inner circle of the CD tray.

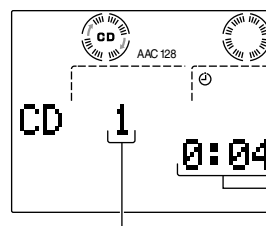

3 Press CD .

The CD tray closes automatically and the unit starts playing the first track of the CD.



Elapsed playing time

Track No.

- When you press  CD instead of CD , the CD tray also closes, but the unit does not start playing.

To stop during playback, press .

The total track number and playing time appear in the main display.

To remove the disc, press  CD on the unit.

About CD indicator



Source is
"CD," but no
CD is loaded



A CD is
loaded



During
playback



During
a pause

Basic CD Operations

While playing a CD, you can do the following operations.

To stop playback for a moment

Press CD ►/||.

To resume play, press CD ►/|| again.

To locate a particular point in a track during play

Press and hold ►►► or ◀◀◀ during play.

- ►►► : Fast-forwards the tracks.
- ◀◀◀ : Fast-reverses the tracks.

To go to another track

Press ►►► or ◀◀◀ repeatedly.

- ►►► : Skips to the beginning of the next or succeeding tracks.
- ◀◀◀ : Goes back to the beginning of the current or previous tracks.

Before starting play, you can continuously skip or go back to any track by holding the button.

To go to another track directly using the number buttons

Pressing the number button(s) on the remote control allows you to start playing the track number you want.

- Ex. For track number 5, press 5.
For track number 15, press +10, then 5.
For track number 20, press +10, then 10.
For track number 32, press +10, +10, +10, then 2.

To change the information shown in the main display

Each time you press DISP/CHARA on the remote control, the information in the main display changes as follows:

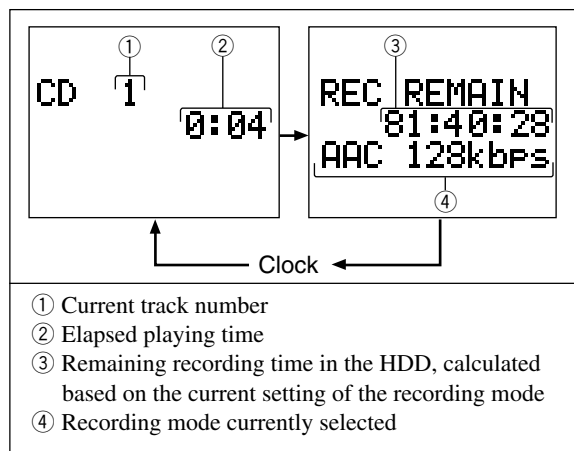

Programing the Playing Order of the Tracks —Program Play

You can arrange the order in which the tracks play before you start playing. You can program up to 32 tracks.

On the remote control ONLY:

- 1 Load a CD.
- 2 Press CD ►/||, then ■.
The source is changed to "CD."
- 3 Press FM/PLAY MODE repeatedly until "CD PROGRAM" appears in the main display.
The PROGRAM indicator lights up on the display.

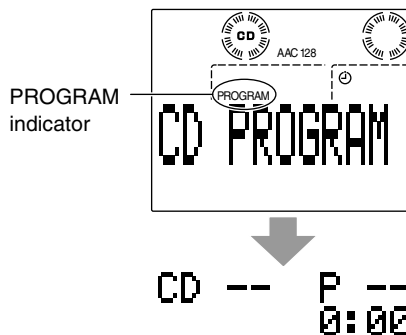

- If a program has been stored in memory, it will be called up.

- Each time you press the button, play modes change as follows:

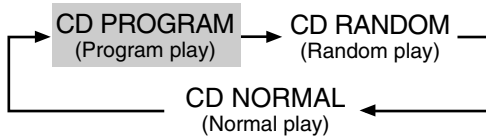

4 Press the number buttons to select the tracks you want.

- For how to use the number buttons, see “To go to another track directly using the number buttons” on page 25.

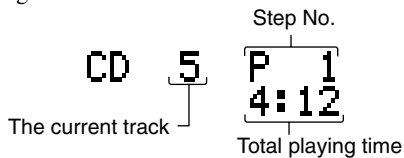

Ex. Track No. 5 is selected for the first step

5 Press CD ►/II.

The tracks are played in the order you have programmed. Program play ends when all the programmed tracks are played (unless Repeat play is activated).

To stop during play, press ■.

To exit from Program play mode, press FM/PLAY MODE once or twice after stopping the playback so that the unit enters another play mode (Random play or Normal play).

To check the program contents

Before playing, you can check the program contents by pressing ◀◀ or ▶▶ on the remote control.

- ◀◀ : Shows the programmed tracks in the reverse order.
- ▶▶ : Shows them in the programmed order.

To modify the program

Before playing, you can erase the last programmed track by pressing CANCEL. Each time you press the button, the last programmed track is erased from the program.

To add tracks in the program before you start play, simply select track numbers you want to add.

To erase the entire program, after stopping the playback, press and hold CANCEL until “CD PROGRAM ALL CLEAR” appears in the main display.

- Turning off the unit or ejecting a CD also erases the entire program.



If you try to program a 33rd step

“MEMORY FULL” will appear in the main display.



If your entry is ignored

You have tried to program a track number that does not exist on the CD (for example, selecting track 14 on a CD that only has 12 tracks). Such entries are ignored.



If the total playing time is over “1:39:59”

The total playing time will not be shown. (“--:--” will appear.)

Playing at Random—Random Play

The tracks of a loaded CD will play at random.

On the remote control ONLY:

1 Load a CD.

2 Press CD ►/II, then ■.

The source is changed to “CD.”

3 Press FM/PLAY MODE repeatedly until “CD RANDOM” appears in the main display.

The RANDOM indicator lights up on the display.

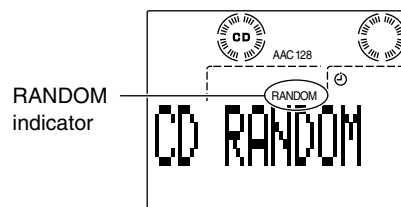

- Each time you press the button, play modes change as follows:

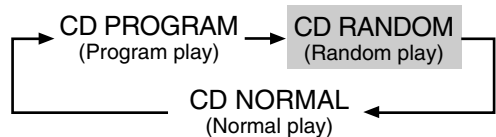

4 Press CD ►/II.

The tracks are played at random.

Random play ends when all the tracks are played once (unless Repeat play is activated).

To skip the playing track, press ►►.

- You cannot go back to the previous tracks by pressing ◀◀.

To stop during playback, press ■.

To exit from Random play mode, press FM/PLAY MODE once or twice after stopping the playback so that the unit enters another play mode (Normal play or Program play).

- Pressing one of the number buttons also starts Normal play with the track selected with the number button.

Repeating Tracks or CD—Repeat Play

You can have all the tracks, the program or the individual track currently playing repeat as many times as you like.

On the remote control ONLY:

To repeat play, press REPEAT during or before play. The corresponding Repeat indicator lights up on the display.

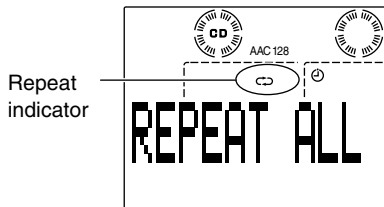

- Each time you press the button, Repeat play changes as follows:

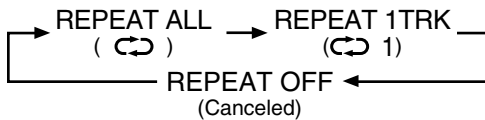

REPEAT ALL : Repeats all the tracks on the CD (in Normal play or Random play), or all the tracks in the program.

REPEAT 1TRK: Repeats one track.

REPEAT OFF : Cancels Repeat play.

To cancel Repeat play, press REPEAT repeatedly until “REPEAT OFF” appears in the main display. The Repeat indicator goes off from the display.

Prohibiting Disc Ejection—Disc Lock

You can prohibit CD ejection from the unit and can lock a CD.

To prohibit CD ejection, follow the procedure below:

On the unit ONLY:

- 1 Press and hold ■ when the unit is in standby mode.
- 2 Press ▲ CD.

LOCKED

The display dims, “LOCKED” appears in the main display for a while, and the loaded CD is locked.

- 3 Release your finger from ■.



notes If you try to eject the locked CD “LOCKED” appears to inform you that the Disc Lock is in use.

To cancel the prohibition and unlock the CD, repeat the above procedure.

The display dims, and “UNLOCKED” appears in the main display for a while in step 2, and the loaded CD is unlocked.

UNLOCKED

Playing Back the HDD (Hard Disk Drive)

The buttons enlarged in the illustration below are used and explained in this section (pages 29 to 37).

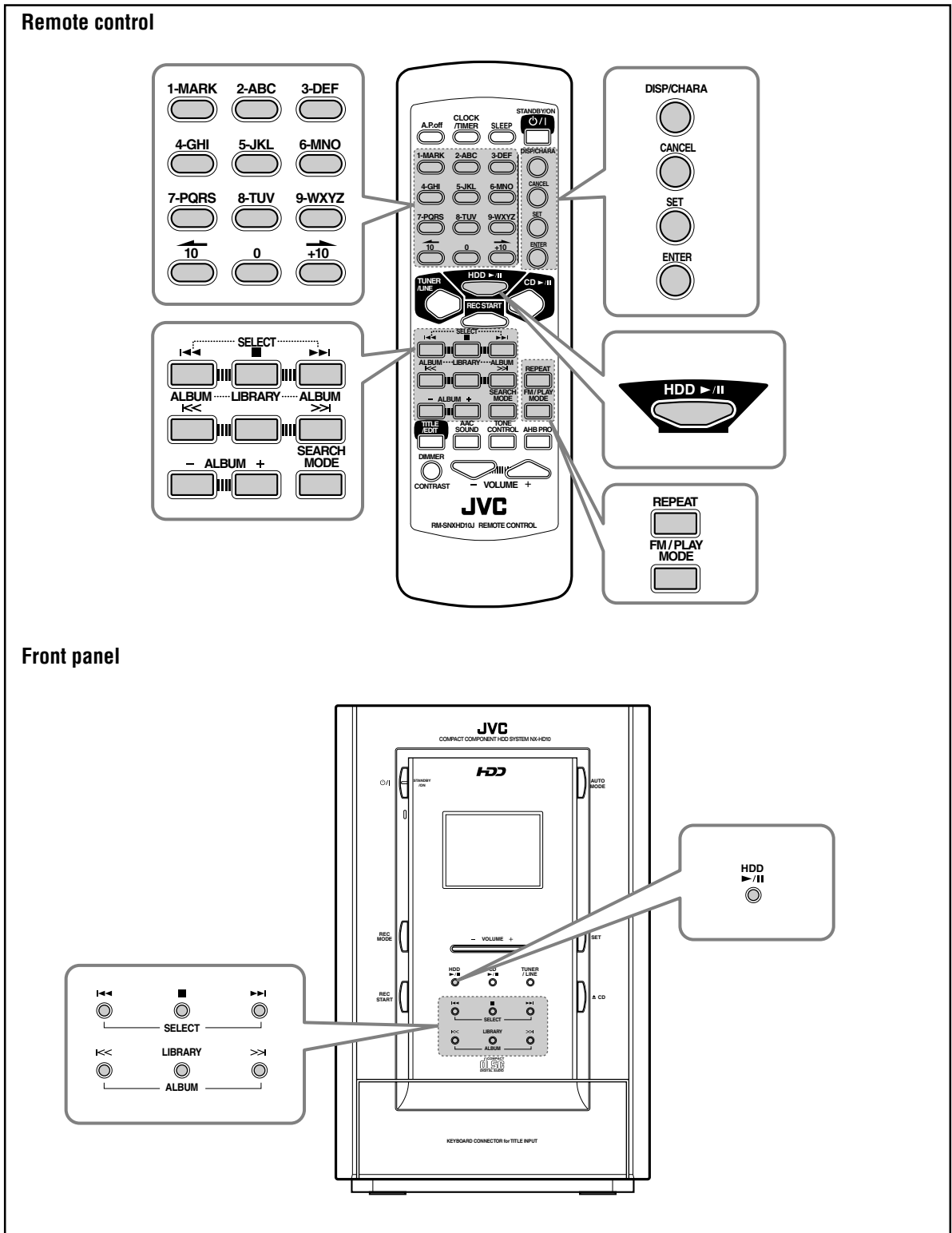

To play back the HDD, you must record tracks yourself first. To record into the HDD, see “Recording into the HDD” on pages 38 to 47.

How tracks are recorded into the HDD

Once you record a song, it is recorded as a “track,” then these recorded tracks can be grouped into an “album.” For example, if you record the entire CD into the HDD, all tracks of the CD are recorded as separate tracks and the entire CD can be considered and grouped as an album.

You can record and store these albums separately into 10 “libraries.”

In other words, tracks recorded in the HDD are grouped into albums, and albums are located in 10 libraries.

- The maximum number of tracks in an album is 254, and that of albums in a library is 100 (the maximum number of the albums in the HDD is 999).
- The HDD also has two more libraries—“Library CD” and “Library TUNER.” For details on these libraries, see pages 41 and 42.

HDD Configuration

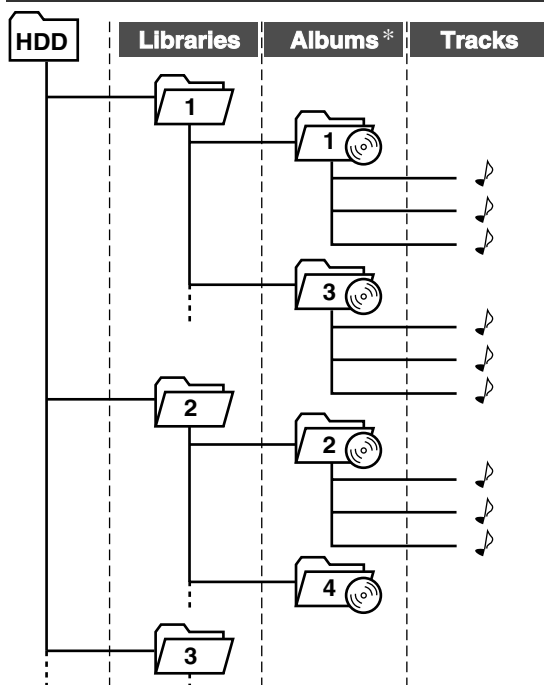

* Albums are automatically numbered in chronological order.

Playing Back the Entire HDD —Continuous Play

You can play back all tracks recorded in the HDD continuously.

1 Press HDD ▶/⏸.

The unit automatically turns on and the HDD lamp starts flashing (in blue).

After the HDD lamp stops flashing and remains lit, the first track of the last selected or recorded album*¹ starts playing.

- During play, the HDD produces a silence of about 2 seconds between each track.

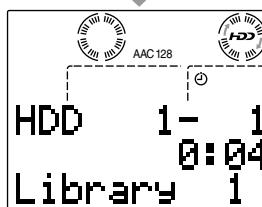
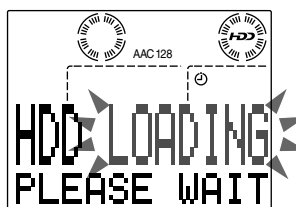

Album No. & Track No.

Elapsed playing time

Library No. or name*²

(If a title is assigned to the current track, it will appear before library number or name.)

*¹ If you have just made a new recording, the unit will start playing the new recording rather than the last selected album.

*² If a name has been assigned to the selected library (see page 53), its assigned name will be shown. (If a name is long and cannot be shown at a time, the unit keeps scrolling the name to show the entire name.)

To stop during play, press ■.

To change the information shown in the main display

Each time you press DISP/CHARA on the remote control, the information in the main display changes as follows:

• Before playing—

① Current album number
 ② Total track number in the current album
 ③ Current library number (or assigned name)
 ④ Album title* appears following "ALBUM TITLE"
 ⑤ Total playing time of the current album
 * If no title is assigned, "NO TITLE" will appear.

• While playing—

① Current album number
 ② Current track number
 ③ Current library number (or assigned name)
 ④ Elapsed playing time of the track
 ⑤ Album title* appears following "ALBUM TITLE"
 ⑥ Track title* appears following "TRACK TITLE"
 * If no title is assigned, "NO TITLE" will appear.



If assigned titles (album title or track title) are long and cannot be shown at a time

The unit keeps scrolling the title to show the entire title.

About HDD indicator



Source is "HDD," but no data is recorded



Ready to play



During playback



During a pause

About HDD lamp

(when dimmer is not activated)

- Blue (flashes) : HDD is preparing for playback. (During this period, no remote control operations are accepted.)
- Blue (lights) : HDD is now ready for playback and for recording, or it is now playing or pausing.
- Red (flashes) : HDD is preparing for recording.
- Red (lights) : HDD is now recording.

Basic HDD Operations

While playing a track recorded in the HDD, you can do the following operations.

To stop playback for a moment

Press HDD ▶/||.

To resume play, press HDD ▶/|| again.

To locate a particular point in a track during play

Press and hold ▶▶| or |◀◀ during play.

- ▶▶| : Fast-forwards the tracks.
- |◀◀ : Fast-reverses the tracks.

To go to another track

Press ▶▶| or |◀◀ repeatedly.

- ▶▶| : Skips to the beginning of the next or succeeding tracks.
- |◀◀ : Goes back to the beginning of the current or previous tracks.

Before starting play, you can continuously skip or go back to any track by holding the button.

To go to another track directly using the number buttons (in the same album)

Pressing the number button(s) **on the remote control** allows you to start playing the track number you want.

- Ex. For track number 5, press 5.
 For track number 15, press +10, then 5.
 For track number 20, press +10, then 10.
 For track number 32, press +10, +10, +10, then 2.

To select another album

Within the same library: Press ALBUM >>I or ALBUM I<<.

- ALBUM >>I : Skips to the first track of the succeeding albums.
- ALBUM I<< : Goes back to the first track of the previous albums.

Beyond the libraries: Press ALBUM + or ALBUM - on the remote control.

- ALBUM + : Skips to the first track of the succeeding albums (in the sequence of album numbers—see page 29).
- ALBUM - : Goes back to the first track of the previous albums (in the reverse sequence of album numbers—see page 29).

To select another library

Press LIBRARY.

Each time you press the button, the next library is selected.

- You cannot select libraries without any album recorded.

Playing Tracks in an Album—Album Play

You can play back tracks in an album.

- To make or edit albums, see pages 40 to 47, and 54 to 56.

On the remote control ONLY:

- 1 Press HDD ►/II, then ■.
The source is changed to “HDD.”
- 2 Press FM/PLAY MODE repeatedly until “HDD ALBUM” appears in the main display.
The ALBUM indicator lights up on the display.

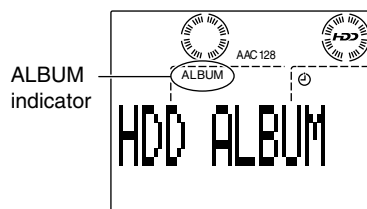

- Each time you press the button, play modes change as follows:

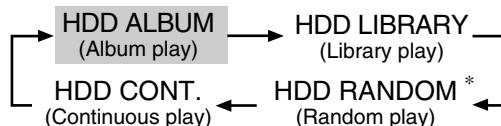

- * The last recorded (or edited) album will be selected as the current album when “HDD RANDOM” appears in the main display while selecting a play mode you want.

- 3 Press ALBUM + or ALBUM - to select an album.

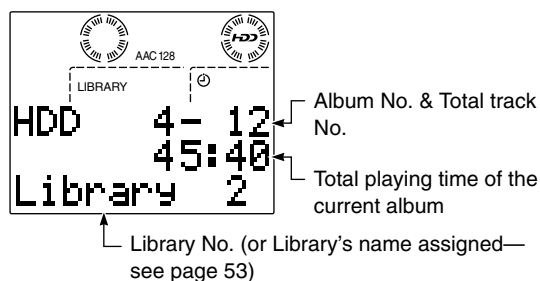

- You can also select an album following the procedure below:
 - ① Press LIBRARY to select a library where an album you want is included
 - ② Press ALBUM >>I or ALBUM I<< to select the album.

4 Press HDD ►/||.

The tracks in the album are played.
Album play ends when all the tracks in the album are played once.

- If you move to another album during Album play, another Album play starts with the newly selected album.

To go to another track in the same album, press ►► or ◀◀ repeatedly or directly press the number button(s) for the track you want.

To stop during play, press ■.

To exit from Album play mode, press FM/PLAY MODE repeatedly after stopping the playback so that the unit enters another play mode (Library play, Random play or Continuous play).

Playing Albums in a Library—Library Play

You can play back all albums in a library.

- To make or edit libraries, see pages 40 to 47, and 53 to 55.

On the remote control ONLY:

1 Press HDD ►/||, then ■.

The source is changed to “HDD.”

2 Press FM/PLAY MODE repeatedly until “HDD LIBRARY” appears in the main display.

The LIBRARY indicator lights up on the display.

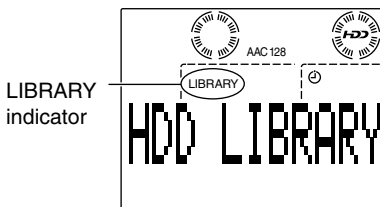

- Each time you press the button, play modes change as follows:

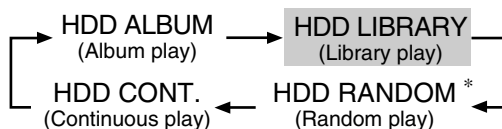

- * The last recorded (or edited) album will be selected as the current album when “HDD RANDOM” appears in the main display while selecting a play mode you want.

3 Press LIBRARY to select a library (Library 1 – Library 10, Library CD or Library TUNER).

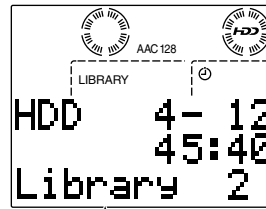

Album No. & Total track No.

Total playing time of the current album

Library No. (or Library's name assigned—see page 53)

4 Press HDD ►/||.

The albums in the library are played.
Library play ends when all the albums in the library are played once.

- If you move to another library during Library play, another Library play starts with the newly selected library.

To go to another album in the same library, press ALBUM >>| or ALBUM |<< repeatedly.

To go to another track in the same album, press ►►| or ◀◀ repeatedly or directly press the number button(s) for the track you want.

To stop during play, press ■.

To exit from Library play mode, press FM/PLAY MODE repeatedly after stopping the playback so that the unit enters another play mode (Random play, Continuous play, or Album play).



If a name has been assigned to the selected library

Its assigned name will be shown. (If a name is long and cannot be shown at a time, the unit keeps scrolling the name to show the entire name.)

Playing at Random—Random Play

All the tracks in the HDD will play at random and repeat endlessly.

On the remote control ONLY:

1

Press HDD ►/II, then ■.

The source is changed to “HDD.”

2

Press FM/PLAY MODE repeatedly until “HDD RANDOM” appears in the main display.

The RANDOM and  indicators light up on the display.

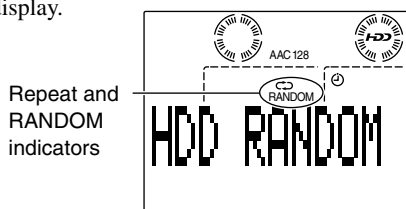

- Each time you press the button, play modes change as follows:

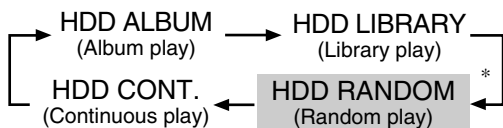

- * The last recorded (or edited) album will be selected as the current album when “HDD RANDOM” appears in the main display while selecting a play mode you want.

3

Press HDD ►/II.

All tracks in the HDD are played repeatedly and endlessly.

To skip the playing track, press ►►I.

- You cannot go back to the previous tracks by pressing I◀◀.

To stop during play, press ■.

To exit from Random play mode, press FM/PLAY MODE repeatedly after stopping the playback so that the unit enters another play mode (Continuous play, Album play, or Library play).

- Pressing one of the number buttons also starts Continuous play with the track selected with the number button.



You cannot select a library or album during Random play

During Random play, you cannot use the following buttons—LIBRARY, ALBUM +/-, and ALBUM I◀◀/►►I.

Repeating Tracks—Repeat Play

You can repeat the tracks in the HDD as many times as you like. What you can repeat differs depending on the current play mode selected—Continuous play, Album play, Library play, or Random play.

On the remote control ONLY:

To repeat play, press REPEAT during or before play.

The corresponding Repeat indicator lights up on the display.

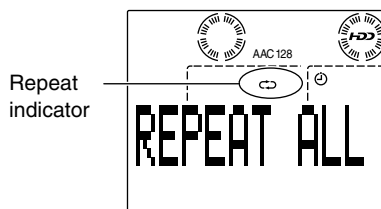

- Each time you press the button, Repeat play changes as follows:

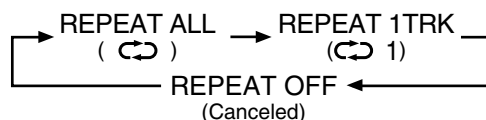

REPEAT ALL : For Continuous and Random plays:
Repeats all the tracks in the HDD.
For Album play: Repeats all the tracks in the current or selected album.
For Library play: Repeats all the albums in the current or selected library.

REPEAT 1TRK: Repeats one track.

REPEAT OFF : Cancels Repeat play except for Random play.

To cancel Repeat play, press REPEAT repeatedly until “REPEAT OFF” appears in the main display. The Repeat indicator goes off from the display.



You cannot cancel Repeat play during Random play
During Random play, you can only select either “REPEAT ALL” or “REPEAT 1TRK.”

Searching for Albums and Tracks to Play— Search Modes

This unit features the following four Search Modes to give you an easy access to the albums or tracks you want.

- **Album Number Search (ALBUM No.)** : See below.
To select and play an album after searching for it by its number.
- **Album Title Search (ALBUM T.)** : See page 35.
To select and play an album after searching for it by its title.
- **Track Title Search (TRACK T.)** : See page 35.
To select and play a track after searching for it by its title.
- **Last 10 Search (LAST 10)** : See page 37.
To select and play one of the last 10 albums recently played or recorded.

- You can use a PC-compatible keyboard for the following Search Mode operations (see page 69).
- Album play, Library play, Random play, and Repeat play are canceled when you press SEARCH MODE (Continuous play will resume).

To search for an album by its number—ALBUM No.

You can easily find and start playing an album by designating its album number.

On the remote control ONLY:

1 Press HDD ►/II, then ■.

The source is changed to “HDD.”

- If you have already started playback, you can skip this step.

2 Press SEARCH MODE repeatedly until “ALBUM No.?” is selected for “SEARCH MODE.”

The SEARCH and ALBUM indicators light up on the display.

SEARCH and ALBUM indicators

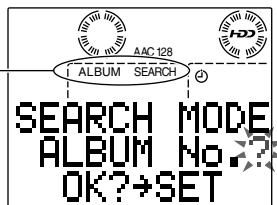

- Each time you press the button, Search Modes change as follows:

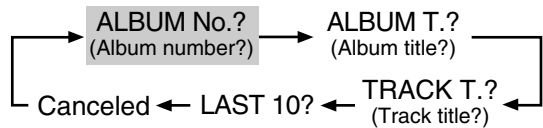

3 Press SET to enter the album number entry screen.

The first number entry position starts flashing.

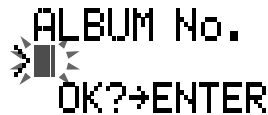

4 Press the number buttons to enter an album number you want, then press ENTER.

The selected album starts playing in Continuous play.

- If the selected album number does not exist, Search Mode is canceled.

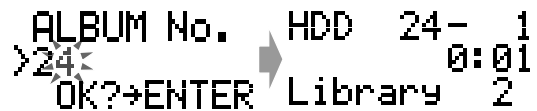

Ex. When selecting album 24

- Ex. For album number 5, press 5, then ENTER.
For album number 10, press 1, 0, then ENTER.
For album number 36, press 3, 6, then ENTER.
For album number 204, press 2, 0, 4 then ENTER.

For album number 1, you can also press ALBUM -, then ENTER.
For the last album number, you can also press ALBUM +, then ENTER.

To search for an album or a track by entering its title —ALBUM T./TRACK T.

You can easily find and play an album or a track by entering its title (up to the first 5 characters)—Album Title Search or Track Title Search.

- Capital letters and small letters are considered as different letters. So, if you enter “ABC,” you cannot search for an album or track named “abc.”
- If a large number of albums and tracks have been recorded in the HDD, the unit will take a long time for searching.
- For details on assigning a title, see pages 48 to 50.

On the remote control ONLY:

1 Press HDD ►/II, then ■.

The source is changed to “HDD.”

- If you have already started playback, you can skip this step.

2 To search for an album title, press SEARCH MODE repeatedly until “ALBUM T.?” is selected for “SEARCH MODE.”

The SEARCH and ALBUM indicators light up on the display.

- Playback stops if you press SEARCH MODE during play.

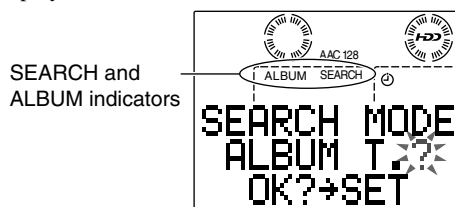

To search for a track title, press SEARCH MODE repeatedly until “TRACK T.?” is selected for “SEARCH MODE.”

The SEARCH indicator lights up on the display.

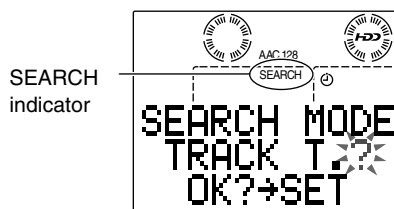

- Each time you press the button, Search Modes change as follows:

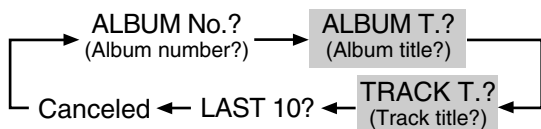

3 Press SET to enter the title entry screen.

The first character entry position starts flashing.

When you have selected Album Title Search in step 2

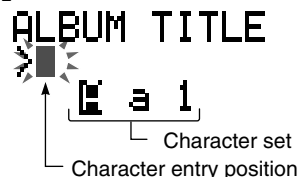

When you have selected Track Title Search in step 2

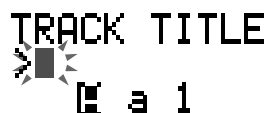

4 Enter a character(s) to search for the title.

- You can enter up to the first 5 characters to search for the album or track you want. The unit will search for the titles with the entered characters at the beginning of their titles.
- If you want to search for an album or a track without its title assigned, do not enter any character and go to step 5.

1) Press DISP/CHARA to select the character set you want.

- Each time you press the button, the character sets change as follows:

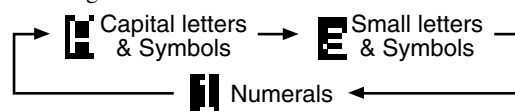

2) Press the character entry button for a character you want to enter.

Examples:

- To enter an “A” or “a,” press ABC once.
To enter a “B” or “b,” press ABC twice.
To enter a “C” or “c,” press ABC three times.
- To enter a symbol, press MARK repeatedly until the mark you want appears (see page 36).
- To enter a numeral, press 0 – 9.
- To enter a space while entering a title, press → twice.
- To insert a character, press → or ← to move the character entry position, then press a character entry button.
- To erase a character, press → or ← to move the character entry position, then press CANCEL.
- To cancel the setting, press SEARCH MODE.

3) Repeat steps 4–1) and 4–2) to enter other characters.

- If the character you want to enter next is assigned to the same button you have just pressed in step 4–2), press \rightarrow once to move the character entry position to the right.

5 Press ENTER.

“SEARCH” flashes in the main display. The unit starts searching for the title.

For Album Title Search:

When the title with the entered characters is found, a retrieved album will be shown in the main display and start playing with the first track.

```
HDD  12-  1
Lily ← Retrieved album number
YES?→SET Retrieved album title
```

To play all tracks in the selected album, no operation is required. After all tracks in the album are played, the unit starts searching for another matching album.

- After all albums are searched, “SEARCH END” appears in the main display and Search Mode is canceled (playback stops and the SEARCH and ALBUM indicators go off).

To skip the current album and search for the next matching album, press ALBUM +.

After all tracks in the selected album are played, the unit starts searching for another matching album.

- After all albums are searched, “SEARCH END” appears in the main display and Search Mode is canceled (playback stops and the SEARCH and ALBUM indicators go off).

To start Continuous play with the current (or selected) album, press SET.

Search Mode is canceled and playback continues in Continuous play (the SEARCH and ALBUM indicators go off).

For Track Title Search:

When the title with the entered characters is found, a retrieved track will be shown in the main display and start playing.

```
HDD  2- 12
BILLY ← Retrieved track number
YES?→SET Retrieved track title
```

To play the selected track, no operation is required. After the track is played, the unit starts searching for another matching track.

- After all tracks are searched, “SEARCH END” appears in the main display and Search Mode is canceled (playback stops and the SEARCH indicator goes off).

To skip the current track and search for the next matching track, press \blacktriangleright .

After the track is played, the unit starts searching for another matching track.

- After all tracks are searched, “SEARCH END” appears in the main display and Search Mode is canceled (playback stops and the SEARCH indicator goes off).

To start Continuous play with the current (or selected) track, press SET.

Search Mode is canceled and playback continues in Continuous play (the SEARCH indicator goes off).

- If no title with the entered characters is found, “NOT FOUND” appears in the main display and Search Mode is canceled (Continuous play mode is resumed).



Available symbols are as follows:

(Blank)	\	~	!	@	#	\$	%	^	&	*
()	-	_	=	+	[{	}]	\
	;	:	'	"	,	<	.	>	/	?

To search for one of the last 10 albums recently played or recorded—LAST 10

You can easily find and play one of the last 10 albums recently played* or recorded.

* Tracks played for more than one second can be stored as the “played” tracks in memory.

On the remote control ONLY:

1 Press HDD ►/||, then ■.

The source is changed to “HDD.”

- If you have already started playback, you can skip this step.

2 Press SEARCH MODE repeatedly until “LAST 10?” is selected for “SEARCH MODE.”

The SEARCH and ALBUM indicators light up on the display.

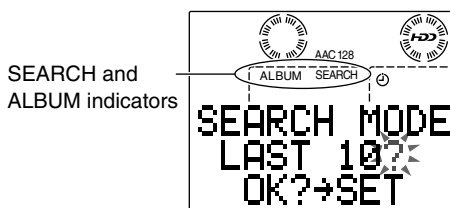

- Each time you press the button, Search Modes change as follows:

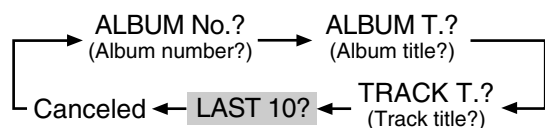

3 Press SET.

The following message appears.

```

    LAST 10
    PLAYED?
    OK?→SET
  
```

4 To find and play the albums recently played, press SET again.

The last played album starts playing (in this example, album number 5—if the selected album has a title, it will appear in the main display instead of the album number).

```

    PLAYED    1
    ALBUM    5
    YES?→SET
  
```

To find and play the albums recently recorded, press SELECT ►► or SELECT ◄◄ to select “RECORDED?,” then SET.

The last recorded album starts playing (in this example, album number 5—if the selected album has a title, it will appear in the main display instead of the album number).

```

    LAST 10    RECORDED 1
    RECORDED?  ALBUM    5
    OK?→SET   YES?→SET
  
```

- Each time you press SELECT ►► or SELECT ◄◄, “PLAYED?” and “RECORDED?” alternately appear.
- To cancel the setting, press SEARCH MODE.

5 Press ALBUM + (or ALBUM -) to select an album you want, then press SET.

The selected album starts playing in Continuous play.

```

    PLAYED    5    HDD    24- 1
    ALBUM    24    0:01
    YES?→SET   Library  2
  
```

Ex. When you want to play the 5th most recently played album



When you unplug the AC power cord or if a power failure occurs

The unit may lose the memory of those recently played or recorded albums.

Recording into the HDD

The buttons enlarged in the illustration below are used and explained in this section (pages 39 to 47).
For this section, it is convenient to use the buttons on the front panel.

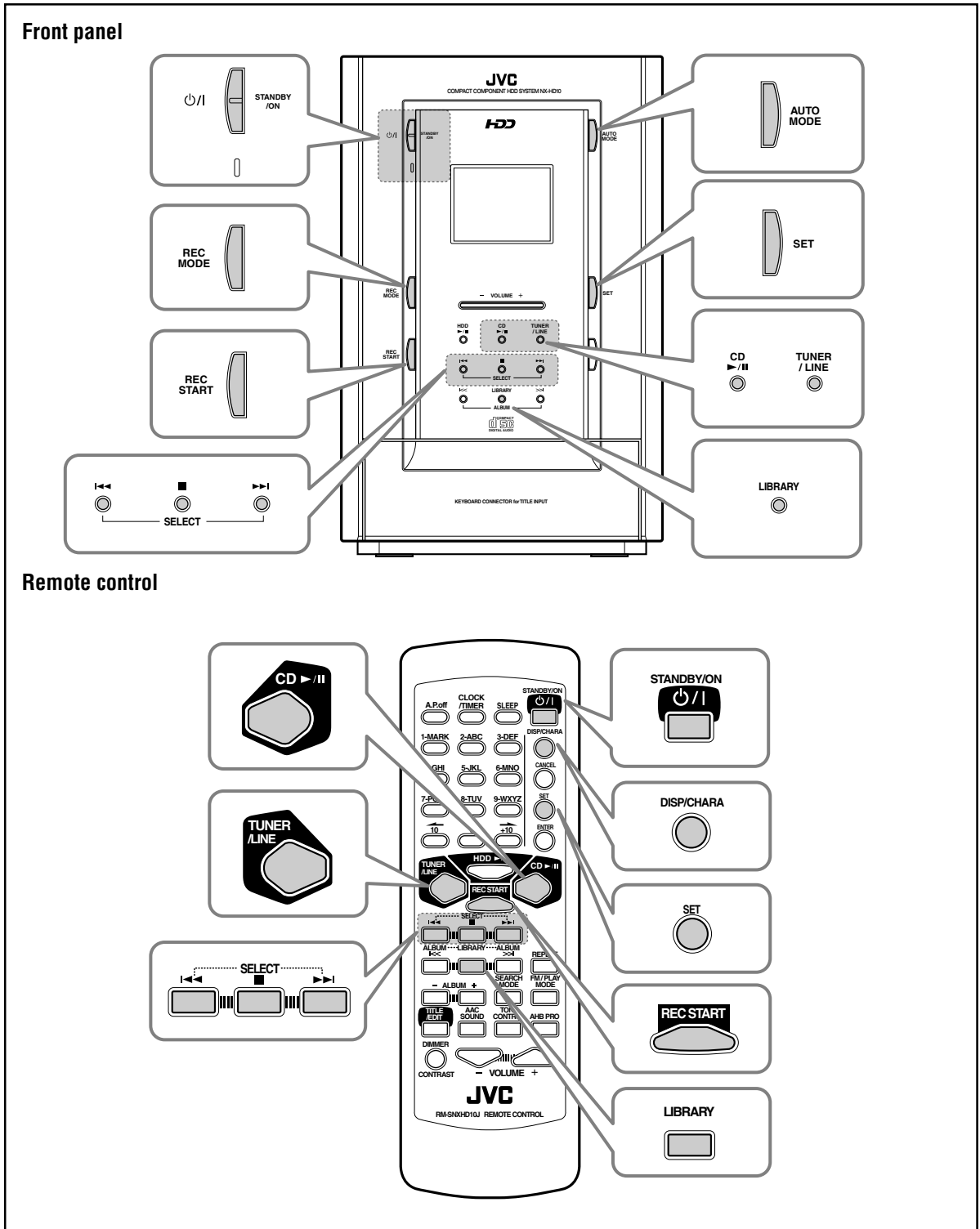

Before You Start Recording

- **It should be noted that it may be unlawful to re-record pre-recorded tapes, records, or discs without the consent of the owner of copyright in the sound or video recording, broadcast or cable programme and in any literary, dramatic, musical, or artistic embodied therein.**
- Tracks of less than 3 seconds cannot be created (or recorded) in the HDD.
- Each recording is stored as an album in a library.
- The recording level is not affected by the volume. During recording you can adjust the volume you are actually listening to without affecting the recording level.
- While recording, you can hear the Active Hyper Bass Pro and/or the tone control effect through the speakers or headphones. However, the playback sound is recorded without these effects (see page 15).
- While recording, HDD play modes (Album play, Library play, and Random play) including Repeat play are temporarily canceled.

How the HDD separates the recorded tracks?

When playing back the recordings in the HDD, you can move among the tracks. But why?

- **When recording from CD:**
A track number is assigned automatically at the beginning of each track. (The playing time of the track recorded in the HDD may differ from the original playing time of the track on the CD.)
- **When recording from the external component connected to the LINE IN jacks:**
Only single track number is assigned. This means that the HDD will regard the entire recording as one track. However, if there is a blank of about 3 seconds or more, the HDD will consider it as a blank separating 2 tracks and consequently assign another track number to the latter portion.

To assign a track number manually (except while recording from CD and while recording with Tuner Auto Recording), press SET at the place where you want to assign a track number.

- You cannot assign track numbers manually while recording from CD or recording with Tuner Auto Recording (see page 42).

To assign a track number (in other words, separate a track) after recording is over, you can use the DIVIDE function (see page 60).

About the digital formats used for recordings

When recording into the HDD, you can select either linear PCM or AAC (Advanced Audio Coding) format. Linear PCM format is the one used for regular audio CD. Audio signals are recorded without any compression. On the other hand, AAC is a newly developed audio compression technology which can eliminate over 90 percent of the original signal data without losing the brilliance of the original. This unit allows you to select 128 kbps and 96 kbps as a bit rate*¹.

Allowable recording time differs according to the digital format used. Assuming that only one format is used for all the recordings, recording time will be as follows:

- Linear PCM: About 15 hours*²
- AAC 128 kbps: About 173 hours*²
- AAC 96 kbps: About 227 hours*²

*¹ Bit rate is the average number of bits that one second of audio data will consume. The unit used is kbps (1024 bits/second). To get a better audio quality, choose a higher bit rate. The most popular bit rate for encoding is 128 kbps.

*² These values are theoretically calculated when there is no data recorded. They may differ depending on the recording condition (see page 78).

About the maximum recording length for one track

You cannot continue recording as a single track if its recording time exceeds the following times:

- Linear PCM: About 3 hours.
- AAC 128 kbps/96 kbps: About 24 hours.

Another track number is automatically assigned to the recorded portion exceeding the maximum length.

About SCMS (Serial Copy Management System)

The HDD built in this unit uses the Serial Copy Management System which allows only first-generation digital copies to be made of premastered software such as regular CDs.

If you try to record from a duplicated CD-R or CD-RW into the HDD, "SCMS CANNOT COPY / ANALOG REC" appears in the main display then this unit automatically selects analog recording.

- If double normal speed recording (PCM x2 REC) or four times normal speed recording (PCM x4 REC) is selected for the recording, the recording mode will be automatically changed to normal speed recording (PCM x1 REC).

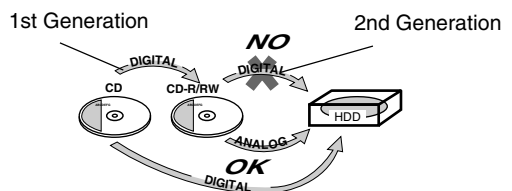

Using Automatic Recording Functions

This unit features three Auto Modes—Smart Compression, CD Auto Recording, and Tuner Auto Recording.

You can activate these functions whether playing a source or not (the unit must be turned on).

- **Smart Compression (SMART COMP.)** : See below.
To automatically compress linear PCM tracks into AAC formatted data.
- **CD Auto Recording (CD AUTO REC)** : See page 41.
To automatically record a CD when playing back a CD entirely (from the first track to the last) in Normal play (see page 24).
- **Tuner Auto Recording (TU AUTO REC)** : See page 42.
To automatically record broadcasts when a station is tuned in.

Auto Modes cannot be set while recording into the HDD.

To automatically compress linear PCM tracks—Smart Compression

You can automatically search for linear PCM tracks and compress (encode) the linear PCM tracks into AAC formatted data when you turn off the unit. You can select your desired bit rate—96 kbps or 128 kbps.

On the unit ONLY:

- 1 Press AUTO MODE repeatedly until “SMART COMP.” appears in the main display.

SMART COMP.
OFF?
OK?→SET

Ex. When the function is currently turned “OFF” (initial setting)

- Each time you press the button, Auto Modes change as follows:

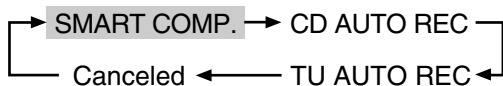

- 2 Press SELECT ►► or SELECT ◀◀ to select “ON?”

SMART COMP.
ON?
OK?→SET

- 3 Press SET.

The SMART COMP. indicator lights up on the display.

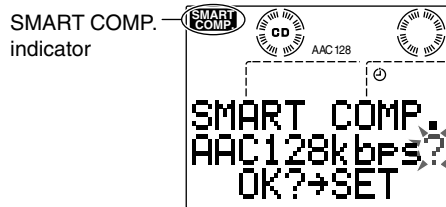

- To cancel the setting, press AUTO MODE.

- 4 Press SELECT ►► or SELECT ◀◀ to select the bit rate—“AAC128kbps” or “AAC 96kbps.”

- 5 Press SET again to finish the setting.

SMART COMP.
AAC128kbps

Ex. When you have selected “AAC128kbps”

To deactivate the function, repeat steps 1 to 3, and select “OFF?” in step 2. The SMART COMP. indicator goes off.

How Smart Compression actually works?

When you turn off the unit by pressing STANDBY/ON ⏻ or by using timers or Auto Power off (see pages 63 to 68), data compression automatically starts.

The display dims, and the SMART COMP. indicator starts flashing on the display. The STANDBY/ON lamp also starts flashing in green.

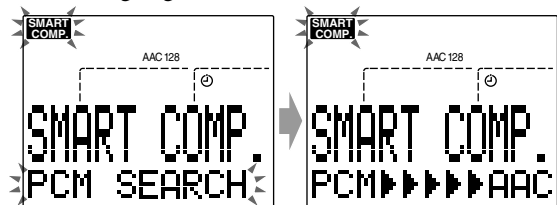

When the compression is complete, Smart Compression is turned off automatically, and the unit goes into standby mode (the STANDBY/ON lamp stops flashing and remains lit in red.)

- It may take a long time (the sum of the playing times of all existing linear PCM tracks plus searching time) for the unit to compress all the PCM tracks. By pressing STANDBY/ON ⏻ again, you can stop compression and make the unit go into standby mode.



Smart Compression always works even if no linear PCM track has been recorded

When you turn off the unit with Smart Compression turned on, it always works because the unit starts searching for linear PCM tracks.

To automatically record CDs—CD Auto Recording

You can automatically make a recording when playing back a CD entirely (from the first track to the last) in Normal play. (You need to start playback by pressing CD ►/II.) The recording will be stored in a library named “Library CD.”

- “AAC 128 kbps” is automatically selected as the recording format.
- CD Auto Recording will not work for Program play, Random play, and Repeat play.
- CD Auto Recording will be canceled when Recording Timer starts operating.

On the unit ONLY:

- 1 Press AUTO MODE repeatedly until “CD AUTO REC” appears in the main display.

CD AUTO REC
OFF?
OK?→SET

Ex. When the function is currently turned “OFF” (initial setting)

- Each time you press the button, Auto Modes change as follows:

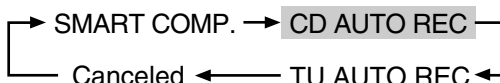

- 2 Press SELECT ►► or SELECT ◀◀ to select “ON?”

CD AUTO REC
ON?
OK?→SET

- 3 Press SET to finish the setting.

The CD and AUTO indicators light up on the display.

CD and AUTO indicators

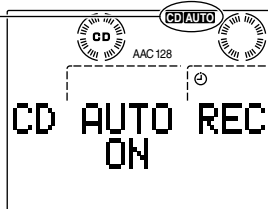

To deactivate the function, repeat steps 1 to 3, and select “OFF?” in step 2.

The CD and AUTO indicators go off.



If you turn on the function while playing a CD Recording will not begin. The function will work next time you start playing a CD.

How CD Auto Recording actually works?

Recording automatically starts when you start CD play in Normal play by pressing CD ►/II.

The HDD lamp lights in red, and the CD and AUTO indicators start flashing on the display.

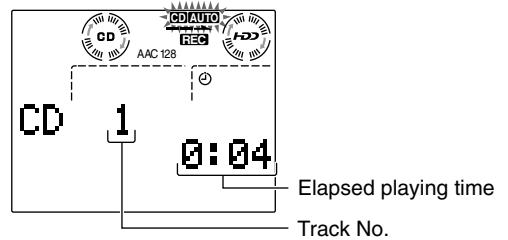

CD Auto Recording will be automatically canceled if—

- you turn off the unit
 - you change the source
 - you stop, skip, search, pause or eject CD
 - you select a track number directly
 - you deactivate CD Auto Recording
- Recording will not be stored in “Library CD.”



If you press ■ or ▲ CD while CD Auto Recording is performed

“PLEASE WAIT” may appear in the main display for a moment.

To change the information shown in the main display while recording

Each time you press DISP/CHARA on the remote control, the information in the main display changes as follows:

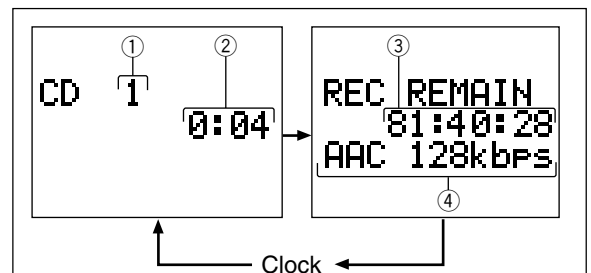

- ① Current track number
- ② Elapsed playing time
- ③ Remaining recording time in the HDD (counts down about every 10 seconds), calculated based on the current setting of the recording mode
- ④ Current recording mode



If you play a digitally duplicated CD-R or CD-RW CD Auto Recording will not start. To record a disc of this type, use the ordinary recording methods described on pages 43 and 44.



If the recording is not done correctly or a track is skipped while it is being played

Use analog recording (see page 47).



If “CD AUTO REC OFF PLEASE!” appears in the main display

You have tried to do the following operations while CD Auto Recording is performed.

- To select recording modes or start recording
- To edit recording or assign the title to an album or a track
- To select Repeat play

These operations cannot be accepted during CD Auto Recording.

To automatically record broadcast programs —Tuner Auto Recording

You can automatically record broadcast program(s) while you are tuning in to the FM or AM stations. So you can always keep the most recent tuned program(s) for up to 30 minutes in the HDD. When you stop tuning in to the FM/AM stations, Tuner Auto Recording stops.

These recorded program(s) will be stored as a single track in a single album in a library named “Library TUNER.”

- “AAC 96 kbps” is automatically selected as the recording format.
- Tuner Auto Recording will be canceled when Recording Timer or Daily Timer starts operating.

IMPORTANT: With Tuner Auto Recording activated, recording in “Library TUNER” is automatically erased and overwritten if you tune in to an FM or AM station after—

- you have selected any source other than FM/AM, or
- you have turned off the unit.

If you want to keep an important recording done using Tuner Auto Recording, copy the album in “Library TUNER” before it is erased. To copy the album, use the COPY ALBUM function (see page 54).

On the unit ONLY:

- 1 Press AUTO MODE repeatedly until “TU AUTO REC” appears in the main display.

TU AUTO REC
OFF?
OK?→SET

Ex. When the function is currently turned “OFF” (initial setting)

- Each time you press the button, Auto Modes change as follows:



- 2 Press SELECT ►► or SELECT ◄◄ to select “ON?”

TU AUTO REC
ON?
OK?→SET

- 3 Press SET to finish the setting.

The TUNER and AUTO indicators light up on the display.

TUNER and
AUTO indicators

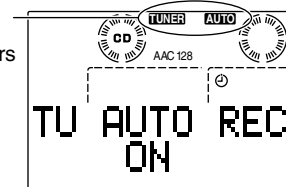

To deactivate the function, repeat steps 1 to 3, and select “OFF?” in step 2.

The TUNER and AUTO indicators go off.



If you turn on the function while tuning in to a station

Recording will start automatically.

How Tuner Auto Recording actually works?

When you tune in to a radio station, recording automatically starts.

The TUNER and AUTO indicators start flashing, and the HDD lamp lights in red.

- If you change the band (from FM to AM only) or the stations, recording continues.
- If you turn off the unit while Tuner Auto Recording is being performed, it will not re-start working for about one minute next time you turn on the unit.

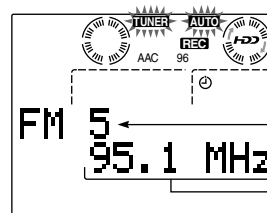

Preset station number if any

Station frequency

To stop recording, deactivate the function (repeat steps 1 to 3, and select “OFF?” in step 2).

- If you press ■, “TU AUTO REC OFF PLEASE!” appears in the main display

Tuner Auto Recording will automatically stop if—

- you turn off the unit
 - you change the source (excluding changing FM to AM)
 - you deactivate Tuner Auto Recording
- Recording done by that time will be stored in “Library TUNER.”

To change the information shown in the main display while recording

Each time you press **DISP/CHARA** on the remote control, the information in the main display changes as follows:

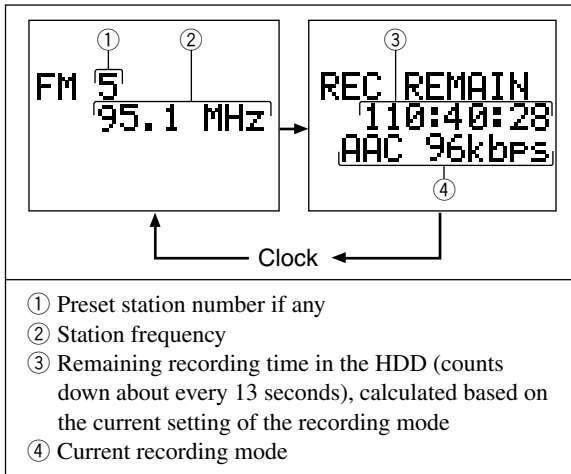

If “TU AUTO REC OFF PLEASE!” appears in the main display

You have tried to select recording modes or start recording while Tuner Auto Recording is performed. These operations cannot be accepted during Tuner Auto Recording.



If you want to record the current broadcast program for more than 30 minutes

With this function, you can record only the most recent 30 minutes of the program. To record the entire program, first deactivate the Tuner Auto Recording, then perform the recording procedure explained on page 45.

Recording CDs

This unit is equipped with the following recording modes to record CDs.

- **AAC128kbps** : To record in AAC format at the bit rate of 128 kbps (normal speed).
- **AAC 96kbps** : To record in AAC format at the bit rate of 96 kbps (normal speed).
- **PCM x1 REC** : To record in Linear PCM format (normal speed).
- **PCM x2 REC** : To record in Linear PCM format at double normal speed. (No playback sound will be heard while recording.)
- **PCM x4 REC***: To record in Linear PCM format at four times normal speed. (No playback sound will be heard while recording.)

* You cannot select “PCM x4 REC” to record Program play and Random play.

1 Prepare a CD.

- Press **CD** ►/||, then press **■** after loading a CD.
- You can make a program (see page 25) or select Random play mode (see page 26) if you want. In this case, do not start playing CD manually.

2 Press REC MODE on the unit to select the recording mode.

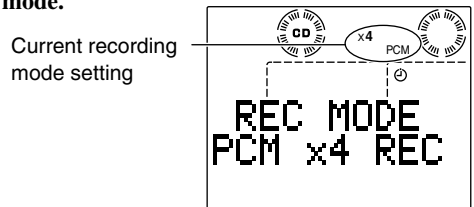

Ex. When selecting “PCM x4 REC”

- Each time you press the button, the recording modes change as follows:

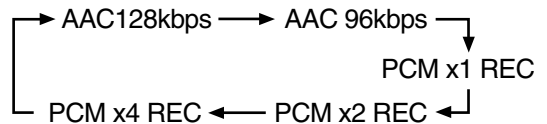

The indicator corresponding to the selected recording mode lights up on the display.

3 Press REC START to start recording.

The REC indicator starts flashing on the display, and CD play and recording start at the same time.

- Repeat play is temporarily canceled if in use.

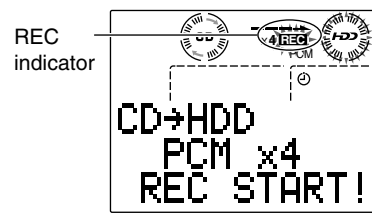

Current track no. of the CD Remaining play time of the current track



Remaining recording time in the HDD*

* Remaining recording time is calculated based on the current setting of the recording mode.

When CD play ends, recording also stops and the following message appears in the main display.



4 Press LIBRARY to select a library where you store the recording just done.

- Each time you press LIBRARY, the library changes—“Library 1” to “Library 10.”
- If you do not select any library within one minute, the library currently flashing in the main display is automatically selected.

5 Press SET to finish the recording.

“ENTRY” flashes in the main display for a while.

To stop while recording, press ■.

The following message also appears in the main display. So follow steps 4 and 5 above (press LIBRARY repeatedly to select a library, then press SET).

```
ENTRY LIB.
Library 1 ← *1
OK?→SET
```

To record a single track during playback

Press REC START while the desired track on the CD is played back (regardless of the play mode).

The playback of that CD track stops, and the same track starts playing back from the beginning again. Then, the recording starts (with the currently selected recording mode).

```
1TRK→HDD
PCM x2
REC START!
```

When the playback of the current track is over, recording also stops and the following message appears.

```
ENTRY LIB.
Library 1 ← *1
OK?→SET
```

Follow steps 4 and 5 above (press LIBRARY repeatedly to select a library, then press SET).



If a name has been assigned to the selected library Its assigned name will be shown.



If “CD AUTO REC OFF PLEASE!” appears in the main display

You cannot record a track using this method while CD Auto Recording is being performed (see page 41).

To change the information shown in the main display while recording

Each time you press DISP/CHARA on the remote control, the information in the main display changes as follows:

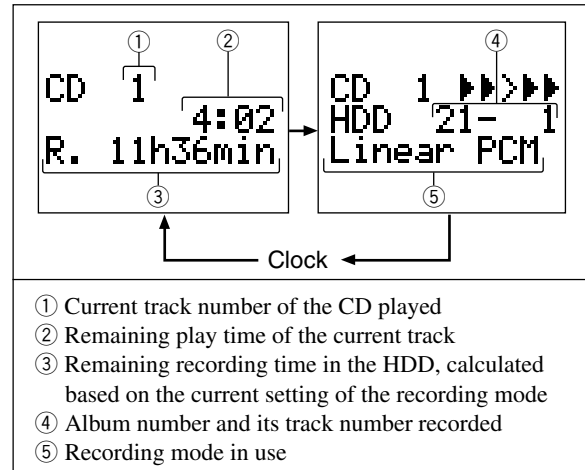

If you cannot record a CD using high speed recording (PCM x2 REC or PCM x4 REC)

This might have occurred due to the recording condition of the disc. Using a slower speed recording than the current one in use (PCM x1 or PCM x2) may solve this trouble.



If the recording is not done correctly, or a track is skipped while it is being played

Use analog recording (see page 47).



Tracks of less than 3 seconds cannot be created (or recorded) in the HDD.

During the first 3 seconds of recording of each track, you cannot stop recording.

*1 Prior to this operation;

- If you have turned off and on the unit, or if you have recorded another source—FM, AM, or external component, “Library 1” will appear.
- If you have recorded CDs, the last recorded library will appear.

Recording FM/AM Broadcasts

This unit is equipped with the following recording modes to record broadcast programs.

- **AAC128kbps** : AAC format is used at the bit rate of 128 kbps.
- **AAC 96kbps** : AAC format is used at the bit rate of 96 kbps.

1 Tune in to a station you want (see page 18).

2 Press REC MODE on the unit to select the recording mode.

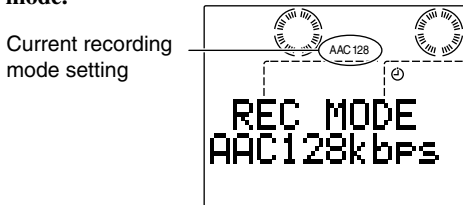

Ex. When selecting "AAC128kbps"

- Each time you press the button, the recording modes change as follows:

AAC128kbps ↔ AAC 96kbps

The indicator corresponding to the selected recording mode lights up on the display.

3 Press REC START to start recording.

The REC indicator lights up on the display and the recording starts.

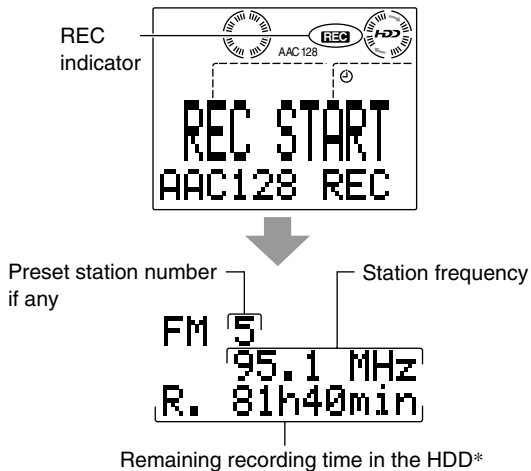

* Remaining recording time is calculated based on the current setting of the recording mode.

4 When the broadcast program ends, press ■ to stop recording.

The following message appears in the main display.

ENTRY LIB.
Library 1
OK?→SET

5 Press LIBRARY to select a library where you store the recording just done.

- Each time you press LIBRARY, the library changes—"Library 1" to "Library 10."
- If you do not select any library within one minute, Library 1 is automatically selected.

6 Press SET to finish the recording.

"ENTRY" flashes in the main display for a while.



If "TU AUTO REC OFF PLEASE!" appears in the main display

You cannot start recording using this method while Tuner Auto Recording is being performed (see page 42 and 43).



While recording, you cannot change the source or station

If you need to change the source or station, stop recording first.

To assign track numbers manually while recording

Press SET at the place where you want to assign another track number.

"TRK INCRE. (increment)" appears in the main display for a while.

TRK INCRE.

- For details, see "How the HDD separates the recorded tracks?" on page 39.

To change the information shown in the main display while recording

Each time you press DISP/CHARA on the remote control, the information in the main display changes as follows:

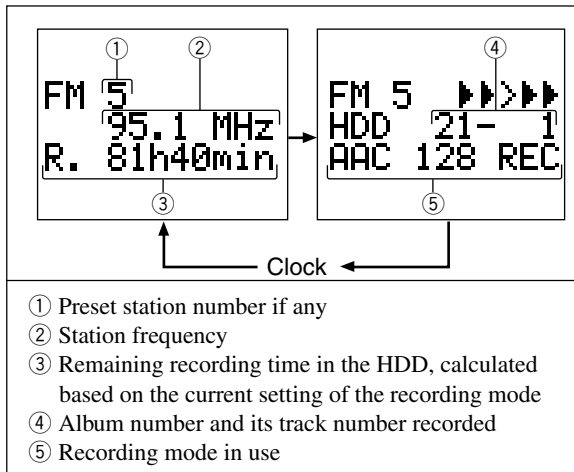

Recording the External Component

You can start recording automatically when the source sound comes into this unit through the LINE IN jacks—Sound Synchronized Recording.

Sound Synchronized Recording will stop automatically if no sound comes in for more than 30 seconds (after making a 30-second silence recording).

This unit is equipped with the following recording modes to record from the external component.

- **AAC128kbps** : AAC format is used at the bit rate of 128 kbps.
- **AAC 96kbps** : AAC format is used at the bit rate of 96 kbps.

1 Press TUNER/LINE repeatedly to select the external component (see page 21).

2 Press REC MODE on the unit repeatedly to select the recording mode.

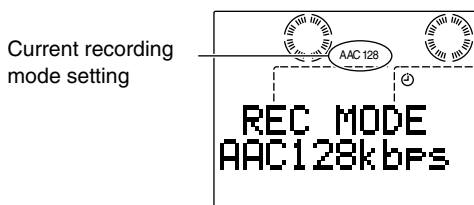

Ex. When selecting "AAC128kbps"

- Each time you press the button, the recording modes change as follows:

AAC128kbps ↔ AAC 96kbps

The indicator corresponding to the selected recording mode lights up on the display.

3 Press REC START.

The REC indicator starts flashing on the display, and the unit now stands by for Sound Synchronized Recording.

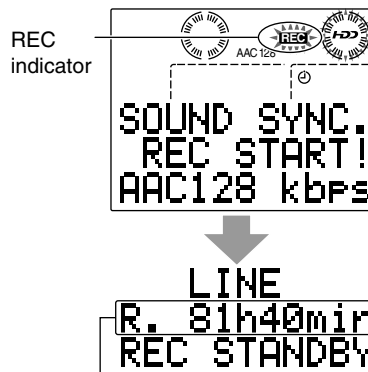

Remaining recording time in the HDD*

- * Remaining recording time is calculated based on the current setting of the recording mode.

- If playback has already started on the external component, the unit will start recording without entering recording standby mode.

4 Start playback on the external equipment.

Recording starts, and the REC indicator stops flashing and remains lit.

- You can also start recording by pressing HDD ►/II.

LINE
R. 81h40min
AAC 128 REC

5 When playback ends, press ■ to stop recording.

The REC indicator goes off, and the following message appears in the main display.

ENTRY LIB.
Library 1
OK?+SET

6 Press LIBRARY to select a library where you store the recording just done.

- Each time you press LIBRARY, the library changes—"Library 1" to "Library 10."
- If you do not select any library within one minute, "Library 1" is automatically selected.

7 Press SET to finish the recording.

“ENTRY” flashes in the main display for a while.

When no sound comes in for more than 30 seconds

Recording stops automatically (after making a 30-second silence recording) and the following message appears in the main display.

```
ENTRY LIB.
Library 1
OK?→SET
```

So follow steps **6** and **7** above (press LIBRARY repeatedly to select a library, then press SET).

- To erase the 30-second silence recording, use the DIVIDE function (see page 60) and the ERASE TRK function (see page 62).

To assign track numbers manually while recording

Press SET at the place where you want to assign another track number.

“TRK INCRE. (increment)” appears in the main display for a while.

```
TRK INCRE.
```

- For details, see “How the HDD separates the recorded tracks?” on page 39.

To change the information shown in the main display while recording

Each time you press DISP/CHARA on the remote control, the information in the main display changes as follows:

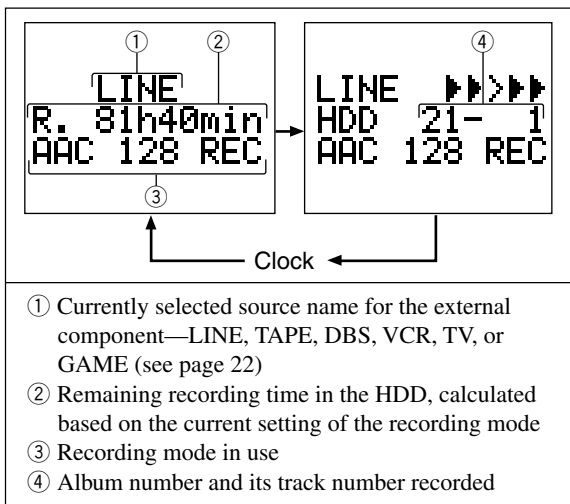

If “Level OVER!” appears while recording Stop recording, then adjust the input level on this unit (see page 21), or if possible adjust the output level on the external component.

- “Level OVER!” will not appear if the album/track numbers or the clock is shown in the main display.

To record CD into the HDD using analog recording mode

If the recording is not done correctly or a track is skipped while it is being played, use the following recording method.

- Track numbers are assigned automatically even when the following analog recording mode is used.

1 Prepare a CD.

- Press CD ►/II, then press ■ after loading a CD.

2 Press and hold REC START until “ANALOG REC START?” appears in the main display.

```
ANALOG REC
START?
OK?→SET
```

- To cancel analog recording, press REC START again.
Or press SELECT ►► or SELECT ◀◀ so that “ANALOG REC CANCEL?” appears in the main display (each time you press the button, “ANALOG REC CANCEL?” or “ANALOG REC START?” alternately appears), then press SET.

3 Press SET.

Analog recording starts.

```
CD→HDD
ANALOG
REC START!
```

- If “PCM x2 REC” or “PCM x4 REC” is currently selected as the recording mode, the recording mode will be automatically changed to “PCM x1 REC.”
- Analog recording mode is automatically canceled when recording is over.
- If you perform steps **2** and **3** above during play, you can record the currently playing track using the analog recording method (see also “To record a single track during playback” on page 44).

Making Your Own Titles

The buttons enlarged in the illustration below are used and explained in this section (pages 49 and 50).

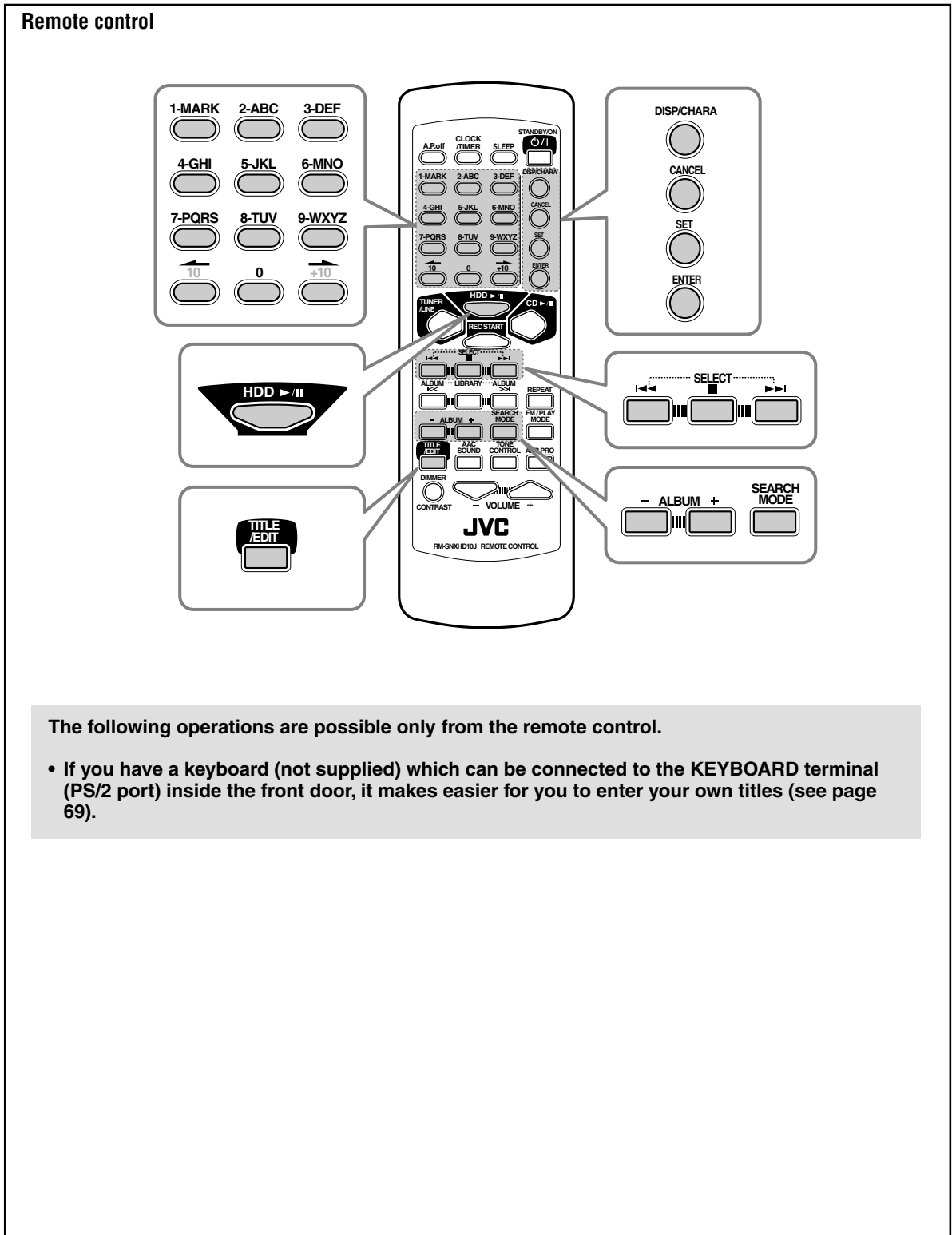

The following operations are possible only from the remote control.

- If you have a keyboard (not supplied) which can be connected to the KEYBOARD terminal (PS/2 port) inside the front door, it makes easier for you to enter your own titles (see page 69).

Assigning Titles to Albums and Tracks

You can assign a title to each album and track. Once a title is assigned, it is displayed during playback.

- The maximum number of the characters used for each title is 64.
- When you want to change the libraries' names, see "Changing the Library Names—LIB. NAME" on page 53.

In the following examples, the processes are explained assuming that the unit is turned on.

- To exit from the title entry screen any time during the process, press TITLE/EDIT.
- To return to the previous screen any time during the process, press CANCEL (except while the title entry screen is shown).

- You cannot enter Title/Edit modes during Random play and Search Modes.
- Library play, Album play, and Repeat play are canceled when you press TITLE/EDIT (Continuous play will resume).
- You can also assign a name to an album and track currently recorded while recording.

To assign a title to an album

On the remote control ONLY:

1 Press TITLE/EDIT once.

- The source changes to "HDD" automatically if another source has been selected.

TITLE?
YES?→SET

- Each time you press the button, Title/Edit modes change as follows:

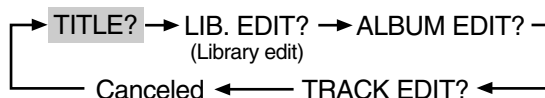

2 Press SET.

TITLE
ALBUM?
OK?→SET

- Each time you press SELECT ►► or SELECT ◄◄, the album title entry mode or the track title entry mode ("TRACK?" or "ALBUM?") is alternately selected.

3 Press SET again.

The unit enters the album title entry mode.

Currently selected album number appears first.

TITLE
ALBUM 3?
OK?→SET

4 Press ALBUM + or ALBUM - to select the album you want to assign a title to, then press SET.

The album title entry screen appears in the main display.

- If a title has been assigned, it will appear.

TITLE
ALBUM 19?
OK?→SET

Character entry position

Character set

Ex. When selecting Album 19

5 Assign the title.

1) Press DISP/CHARA to select the character set you want.

- Each time you press the button, the character sets change as follows:

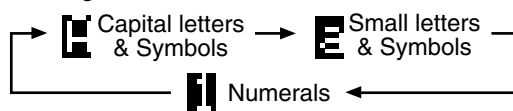

2) Press the character entry button for a character you want to enter.

Examples:

- To enter an "A" or "a," press ABC once.
- To enter a "B" or "b," press ABC twice.
- To enter a "C" or "c," press ABC three times.
- To enter a symbol, press MARK repeatedly until the symbol you want appears (see page 36 for available symbols).
- To enter a numeral, press 0 - 9.
- To enter a space while entering a title, press → twice.
- To insert a character, press → or ← to move the character entry position, then press a character entry button.
- To erase a character, press → or ← to move the character entry position, then press CANCEL.

3) Repeat steps 5 - 1) and 5 - 2) to enter other characters.

- If the character you want to enter next is assigned to the same button you have just pressed in step 5 - 2), press → once to move the character entry position to the right.

6 Press ENTER.

The track title entry screen for the currently selected track appears.

```
TITLE
TRACK 1?
OK?→SET
```

- If you want to go on assigning the track titles, go to step **6** on the right column.

7 Press TITLE/EDIT again to exit from the title entry mode.

If you assign a title during playback

The unit repeats playback of all the tracks of the album until you press ENTER in step **6**. When you press ENTER, the unit enters the track title entry mode.



When you unplug the AC power cord or if a power failure occurs before step **6**

The editing you have made is not recorded in the HDD.

To assign titles to tracks**On the remote control ONLY:****1** Press HDD ►/II.

The source changes to “HDD” automatically if another source has been selected, and HDD playback starts.

- If you do not need to listen to the playback sound, press ■.

2 Select the album where the tracks you want to assign titles to are located (see also page 34).

1) Press SEARCH MODE repeatedly until “ALBUM No.?” is selected for “SEARCH MODE,” then press SET.

2) Press the number buttons to enter an album number you want, then press ENTER.

The first track of the selected album now starts playing.

```
HDD 4- 1
      0:03
Library 2
```

Ex. When selecting Album 4
(it is located in Library 2)

- To select the album number, you can also use ALBUM + or ALBUM - .

3 Press TITLE/EDIT once, then press SET.

```
TITLE?
YES?→SET → TITLE
ALBUM?
OK?→SET
```

4 Press SELECT ►► or SELECT ◀◀ to enter the track title entry mode (“TRACK?”).

- Each time you press the button, the album title entry mode or the track title entry mode (“TRACK?” or “ALBUM?”) is alternately selected.

```
TITLE
TRACK?
OK?→SET
```

5 Press SET.

```
TITLE
TRACK 1?
OK?→SET
```

6 Press the number buttons (or SELECT ►► / SELECT ◀◀) to select the track you want to assign a title to, then press SET.

The track title entry screen for the selected track appears in the main display.

- If a title has been assigned, it will appear.

```
TITLE
TRACK 9?
OK?→SET → TRACK 9
           [ a 1 ]
```

Character entry position Character set

Ex. When selecting Track 9

7 Assign the title by referring step **5** on page 49.**8** Press ENTER.

The next track title entry screen appears.

- If you want to go on assigning more track titles, repeat steps **6** to **8**.
- If you assign a title to the last track in an album or if you assign a title while recording, title entry mode is automatically canceled.

9 Press TITLE/EDIT again to exit from the title entry mode.

For the titles of the duplicated tracks using the COPY ALBUM or COPY TRACK functions (see pages 54 and 57)

The original tracks and their duplicated tracks cannot have different names. If the title of the original track or of the duplicated is changed, the other will also be changed.

Editing the HDD

The buttons enlarged in the illustration below are used and explained in this section (pages 52 to 62).

Remote control

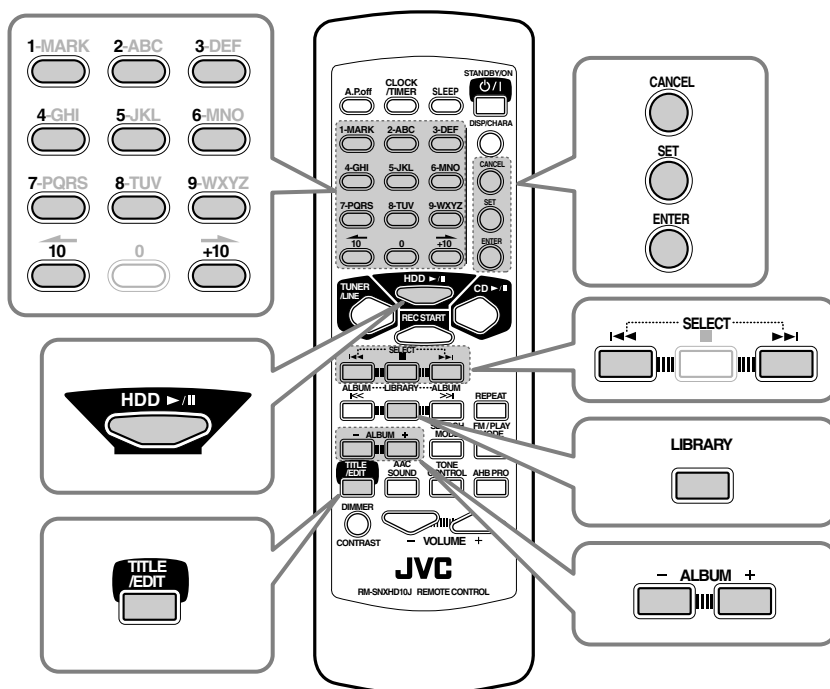

The following operations are possible only from the remote control.

Introducing HDD Editing Functions

You can edit libraries, albums, and tracks using the following functions.

Library Editing

You can change the library name as you like.

- ❑ **Changing the Library Names (LIB. NAME) : Page 53**
You can change the original library name, such as “Library 1,” to the one you assign.
- ❑ **Restoring the Libraries (RESTORE) : Page 54**
If you unplug the unit or if a power failure occurs while recording, compressing (Smart Compression), or editing the data into the HDD, the library information stored in the HDD and what has been actually recorded in the libraries may happen to become unmatched. As a result, you cannot select some tracks or albums as you expect to do in the libraries. If this happens, you can use this function and restore the libraries.

Album Editing

This unit allows you to edit the albums using the following functions.

- ❑ **Copying an Album (COPY ALBUM) : Page 54**
You can make a duplication of an album.
- ❑ **Moving an Album (LIB. CHANGE) : Page 55**
You can move an album from a library to another library.
If you have stored an album in an incorrect library, use this function to change the library to store the album in.
- ❑ **Making a New Album (MAKE ALBUM) : Page 55**
You can create a new album by selecting a track. Album number is automatically assigned to a newly created album.
To make your best album later, add other tracks in this album using the MOVE function. (See page 59.)
- ❑ **Erasing an Album (ERASE) : Page 56**
You can erase an album one by one.
When an album is erased, the subsequent albums are renumbered automatically.
- ❑ **Erasing All Albums (ALL ERASE) : Page 57**
All data in the HDD will be erased.

Track Editing

This unit allows you to edit the tracks using the following functions.

- ❑ **Copying a Track (COPY TRACK) : Page 57**
You can make a duplication of a track.
- ❑ **Copying a Portion of a Track (A-B COPY) : Page 58**
You can copy only a portion of the track you want and store it as a track in an album newly created.
- ❑ **Moving a Track (MOVE) : Page 59**
You can move a track either within the same album or into a different album.
Tracks are automatically renumbered in both albums—where a track has moved from and where the track has moved to.
- ❑ **Dividing a Track (DIVIDE) : Page 60**
This function separates a track into two tracks.
The subsequent tracks are automatically renumbered.
- ❑ **Joining Tracks (JOIN) : Page 61**
This function joins two adjacent tracks into a single track.
The subsequent tracks are automatically renumbered.
- ❑ **Erasing a Track (ERASE TRK) : Page 62**
You can erase an unwanted track one by one.
The subsequent tracks are automatically renumbered.



If the HDD includes many albums

It will be convenient for you to select the album number (and the track number) using Search Mode (see page 34) before performing most of the editing procedures described in this section. If you do so, you do not need to select the album number (and the track number) in the editing procedures.



For the titles of the duplicated albums and tracks using the COPY functions—COPY ALBUM, MAKE ALBUM, and COPY TRACK

The original titles will be also copied and assigned to the newly duplicated albums and tracks.

- **For album titles:** You can change the album titles of the newly duplicated albums later (see pages 49 and 50).
- **For track titles:** You cannot assign the different titles for the original tracks and the duplicated tracks. If the title of the original track or of the duplicated is changed, the other will also be changed.

In the following examples of editing procedures, the processes are explained assuming that the unit is turned on.

- To exit from the editing screen any time during the process, press TITLE/EDIT.
- To return to the previous screen any time during the process, press CANCEL.

- You cannot enter Title/Edit modes during Random play and Search Modes.
- Library play, Album play, and Repeat play are canceled when you press TITLE/EDIT (Continuous play will resume).

Changing the Library Names—LIB. NAME

You can change the library names as you like.

- The maximum number of the characters used for each library name is 64.
- You cannot change the names for “Library TUNER” and “Library CD.”
- Once you change a library name, the changed name will appear instead of the original library name.
- When you want to change the album titles or the track titles, see “Assigning Titles to Albums and Tracks” on page 49.

On the remote control ONLY:

1 Press TITLE/EDIT repeatedly until “LIB. EDIT?” appears in the main display.

- The source changes to “HDD” automatically if another source has been selected.

LIB. EDIT?
YES?→SET

- Each time you press the button, Title/Edit Modes change as follows:

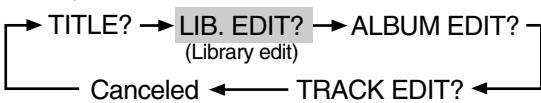

2 Press SET.

LIB. EDIT
LIB. NAME?
OK?→SET

3 Press SET again.

The unit enters the library name entry mode.

LIB. NAME
Library 3
OK?→SET

Currently selected library appears.

4 Press LIBRARY to select a library (“Library 1”—“Library 10”) you want to change the name of, then press SET.

The library name entry screen appears in the main display.

LIB. NAME
Library 9
OK?→SET



Library 9
Library 9
[a 1]

Character entry
position

Character set

Ex. When selecting “Library 9”

5 Press CANCEL repeatedly until the previous name is completely erased.

6 Enter a new name referring to step 5 on page 49.

7 Press ENTER.

“HDD WRITING” appears and the HDD lamp flashes in red while the editing you have made is being stored in the HDD.

- If you have performed the above procedure during play, HDD playback stops.

To restore original library names (when shipped from the factory)

Erasing all characters assigned to a library restores its original library name (“Library 1”—“Library 10”).

Restoring the Libraries—RESTORE

If you unplug the unit or if a power failure occurs while recording, compressing (Smart Compression), or editing the data into the HDD, the Library information stored in the HDD and what has been actually recorded in the libraries may happen to become unmatched. As a result, you cannot skip tracks or albums as you expect to do in the libraries. If this happens, you can use this function and restore the libraries.

- NOTICE if you use the RESTORE function, the following may possibly occur even though the HDD is restored.
 - Library names you have assigned may be reset to the original names.
 - All albums in the HDD may be renumbered newly and be relocated in libraries.

On the remote control ONLY:

1 Press TITLE/EDIT repeatedly until “LIB. EDIT?” appears in the main display, then press SET.

- The source changes to “HDD” automatically if another source has been selected.

LIB. EDIT? → LIB. EDIT
YES?→SET LIB. NAME?
OK?→SET

2 Press SELECT ►► or SELECT ◄◄ to select “RESTORE?”

- Each time you press SELECT ►► or SELECT ◄◄, “RESTORE?” or “LIB.NAME?” is alternately selected.

LIB. EDIT
RESTORE?
OK?→SET

3 Press SET.

<RESTORE>
YES?→ENTER

4 Press ENTER.

“HDD WRITING” appears and the HDD lamp flashes in red while the unit is restoring the libraries.

- If you have performed the above procedure during play, HDD playback stops.

Copying an Album—COPY ALBUM

You can make a duplication of an album. A new album number is automatically assigned to a newly duplicated album.

On the remote control ONLY:

If the HDD includes many albums, select the album number using Search Mode (see page 34) before performing the procedure below.

1 Press TITLE/EDIT repeatedly until “ALBUM EDIT?” appears in the main display.

- The source changes to “HDD” automatically if another source has been selected.

ALBUM EDIT?
YES?→SET

- Each time you press the button, Title/Edit Modes change as follows:

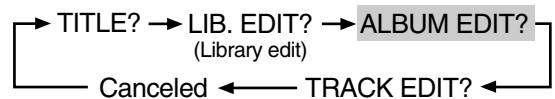

2 Press SET.

ALBUM EDIT
COPY ALBUM?
OK?→SET

3 Press SET again.

COPY ALBUM
ALBUM 35?
OK?→SET

The currently selected album number flashes.

4 Press ALBUM + or ALBUM – to select the album you want to copy, then press SET.

The library selection screen appears.

COPY ALBUM COPY ALBUM
ALBUM 39? → Library 4
OK?→SET OK?→SET

Ex. When selecting Album 9

The currently selected library flashes.

- 5** Press **LIBRARY** to select a library (“Library 1”—“Library 10;”) you want to copy the selected album into, then press **SET**.

Album number is automatically assigned to a newly created album (the youngest unused number will be selected).

```

COPY ALBUM      ALBUM 15
Library 9      Library 9
OK?→SET      YES?→ENTER
  
```

Ex. When selecting “Library 9”

- 6** Press **ENTER**.
 “PLEASE WAIT” then “HDD WRITING” appears and the HDD lamp flashes in red while the editing you have made is being stored in the HDD.
- It takes a long time if the selected album has many tracks.
 - If you have performed the above procedure during play, HDD playback stops.

Moving an Album—LIB. CHANGE

You can move an album from one library to another. If you have stored an album in an incorrect library, use this function to change the library where to store the album into.

On the remote control ONLY:

If the HDD includes many albums, it will be convenient for you to select the album number using Search Mode (see page 34) before performing the procedure below.

- 1** Press **TITLE/EDIT** repeatedly until “**ALBUM EDIT?**” appears in the main display, then press **SET**.

- The source changes to “HDD” automatically if another source has been selected.

```

ALBUM EDIT?    ALBUM EDIT
YES?→SET      COPY ALBUM?
  
```

- 2** Press **SELECT** ►► or **SELECT** ◄◄ to select “**LIB.CHANGE?**,” then press **SET**.

```

ALBUM EDIT    LIB.CHANGE
LIB.CHANGE?  ALBUM 14?
OK?→SET      OK?→SET
  
```

- 3** Press **ALBUM +** or **ALBUM -** to select the album you want to move, then press **SET**.

The library selection screen appears.

```

LIB.CHANGE    LIB.CHANGE
ALBUM 15?    Library 9
OK?→SET      OK?→SET
  
```

Ex. When selecting Album 15 The currently selected library flashes.

- 4** Press **LIBRARY** to select a library (“Library 1”—“Library 10”) you want to move the selected album to, then press **SET**.

The confirmation screen appears in the main display.

```

LIB.CHANGE    ALBUM 15
Library 10?  Library 10
OK?→SET      YES?→ENTER
  
```

Ex. When selecting “Library 10”

- 5** Press **ENTER**.

“HDD WRITING” appears and the HDD lamp flashes in red while the editing you have made is being stored in the HDD.

- If you have performed the above procedure during play, HDD playback stops.

Making a New Album—MAKE ALBUM

You can create a new album by copying a track you want. A new album number is automatically assigned to a newly created album.

On the remote control ONLY:

If the HDD includes many albums and tracks, select the album and track using Search Mode (see page 34) before performing the procedure below.

- 1** Press **TITLE/EDIT** repeatedly until “**ALBUM EDIT?**” appears in the main display, then press **SET**.

- The source changes to “HDD” automatically if another source has been selected.

```

ALBUM EDIT?    ALBUM EDIT
YES?→SET      COPY ALBUM?
  
```

- 2** Press SELECT ►► or SELECT ◀◀ to select “MAKE ALBUM?,” then press SET.

```

ALBUM EDIT  MAKE ALBUM
MAKE ALBUM?  HDD  3-  1
OK?→SET    OK?→SET
  
```

The currently selected track number of the current album flashes.

- 3** Select a track you want to copy to a new album.
- 1) Press ALBUM + or ALBUM – to select the album.
 - 2) Press SELECT ►► or SELECT ◀◀ to select the track.

- You can select the track directly using the number buttons. In this case, the selected track starts playback repeatedly.

```

MAKE ALBUM
HDD  12-  3
OK?→SET
  
```

Ex. When selecting Album 12, then Track 3

- 3) Press SET.

The library selection screen appears.

```

MAKE ALBUM
Library  9
OK?→SET
  
```

The currently selected library flashes.

- 4** Press LIBRARY to select a library (“Library 1”–“Library 10”) you want to move the selected album to, then press SET.

The confirmation screen appears in the main display.

```

MAKE ALBUM  HDD  15-  1
Library 10  Library 10
OK?→SET    YES?→ENTER
  
```

Ex. When selecting “Library 10”

- 5** Press ENTER.

“HDD WRITING” appears and the HDD lamp flashes in red while the editing you have made is being stored in the HDD.

A new album is created (the track selected in step 3 becomes the first track in the new album). Album number is automatically assigned to the newly created album (the youngest unused number will be selected).

- If you have performed the above procedure during play, HDD playback stops.

To make your best album later

A newly created album has only one track. You can add other tracks into this album later using the MOVE function (see page 59).

Erasing an Album—ERASE

You can erase an album one by one.

When an album is erased, the subsequent albums are renumbered automatically.

On the remote control ONLY:

If the HDD includes many albums, select the album number using Search Mode (see page 34) before performing the procedure below.

- 1** Press TITLE/EDIT repeatedly until “ALBUM EDIT?” appears in the main display, then press SET.

- The source changes to “HDD” automatically if another source has been selected.

```

ALBUM EDIT?  ALBUM EDIT
YES?→SET    COPY ALBUM?
              OK?→SET
  
```

- 2** Press SELECT ►► or SELECT ◀◀ to select “ERASE?,” then press SET.

```

ALBUM EDIT  ERASE
ERASE?      ALBUM  2?
OK?→SET    OK?→SET
  
```

The currently selected album number flashes.

- 3** Press ALBUM + or ALBUM – to select an album to erase, then press SET.

The confirmation screen appears in the main display.

```

<ERASE>
YES?→ENTER
  
```

- 4** Press ENTER.

“PLEASE WAIT” then “HDD WRITING” appears and the HDD lamp flashes in red while the editing you have made is being stored in the HDD.

- It takes a long time if the selected album has many tracks.
- If you have performed the above procedure during play, HDD playback stops.

Erasing All Albums—ALL ERASE

All data in the HDD will be erased.

On the remote control ONLY:

1 Press TITLE/EDIT repeatedly until “ALBUM EDIT?” appears in the main display, then press SET.

- The source changes to “HDD” automatically if another source has been selected.

```
ALBUM EDIT? → ALBUM EDIT
YES? → SET      COPY ALBUM?
                  OK? → SET
```

2 Press SELECT ►► or SELECT ◄◄ to select “ALL ERASE?,” then press SET.

The confirmation screen appears in the main display.

```
ALBUM EDIT      <ALL ERASE>
ALL ERASE? →   YES? → ENTER
OK? → SET
```

3 Press ENTER.

The following warning screen appears in the main display.

```
All Data
Will BE Lost
OK? → SET
```

4 Press SET.

The reconfirmation screen appears in the main display.

```
Really?
YES? → ENTER
```

5 Press ENTER again.

The HDD lamp flashes in red and “HDD WRITING” appears while the editing you have made is being stored in the HDD.

- If you have performed the above procedure during play, HDD playback stops.

```
HDD NO DATA
```

Copying a Track—COPY TRACK

You can make a duplication of a track in the same album or in a different album. A newly duplicated track will become the last track in an album where you copy the track into.

On the remote control ONLY:

If the HDD includes many albums and tracks, select the album and track using Search Mode (see page 34) before performing the procedure below.

1 Press TITLE/EDIT repeatedly until “TRACK EDIT?” appears in the main display.

- The source changes to “HDD” automatically if another source has been selected.

```
TRACK EDIT?
YES? → SET
```

- Each time you press TITLE/EDIT, Title/Edit Modes change as follows:

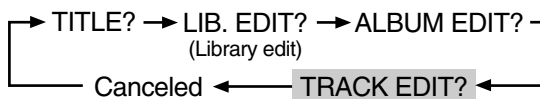

2 Press SET.

```
TRACK EDIT
COPY TRACK?
OK? → SET
```

3 Press SET again.

```
COPY TRK
HDD 2- 1
OK? → SET
```

The currently selected track of the current album flashes.

4 Select a track you want to copy.

- 1) Press ALBUM + or ALBUM - to select the album.
- 2) Press SELECT ►► or SELECT ◄◄ to select the track.

- You can select the track directly using the number buttons. In this case, the selected track starts playback repeatedly.

```
COPY TRK
HDD 5- 9
OK? → SET
```

Ex. When selecting Album 5, then Track 9

3) Press SET.

The album selection screen appears.

```

COPY TRK
▶ ALBUM 57
OK?→SET
  
```

5 Press ALBUM + or ALBUM - to select an album where to copy the track into, then press SET.

```

COPY TRK
▶ ALBUM 97
OK?→SET
  
```

```

<COPY TRK>
YES?→ENTER
  
```

6 Press ENTER.

The editing you have made is being stored in the HDD.

- If you have performed the above procedure during play, HDD playback stops.



If “CANNOT ENTRY LIB. Library TUN” appears in the main display

You have selected the album in “Library TUNER” in step 5. You cannot copy a track into the album in “Library TUNER.”

Copying a Portion of a Track—A-B COPY

You can copy only a portion of the track you want and store it as a new track (the first track) in a new album.

- You cannot set a start point within the first second and set an end point within the last 5 seconds of a track.

On the remote control ONLY:

If the HDD includes many albums and tracks, select the album and track using Search Mode (see page 34) before performing the procedure below.

1 Press TITLE/EDIT repeatedly until “TRACK EDIT?” appears in the main display, then press SET.

- The source changes to “HDD” automatically if another source has been selected.

```

TRACK EDIT?
YES?→SET
  
```

```

TRACK EDIT
COPY TRACK?
OK?→SET
  
```

2 Press SELECT ►► or SELECT ◀◀ to select “A-B COPY?,” then press SET.

The currently selected track starts playing.

```

TRACK EDIT
A-B COPY?
OK?→SET
  
```

```

HDD 2- 2
0:04
POSI.A?→SET
  
```

3 If necessary, select a track you want.

- 1) Press ALBUM + or ALBUM - to select an album.
- 2) Press SELECT ►► or SELECT ◀◀ to select a track.

- You can select the track directly using the number buttons. In this case, the selected track starts playback repeatedly.

By holding SELECT ►► or SELECT ◀◀, you can fast-forward or fast-reverse the track to find the start point.

4 Press SET when you find the start point (POS1.A) for A-B copy.

The portion (of about 2-second length) following the selected start point repeats playing.

```

POSI.A
ADJUST 0
OK?→SET
  
```

5 If necessary, press SELECT ►► or SELECT ◀◀ to precisely adjust the start point.

The unit repeats the newly selected start point.

- You can shift the start point up to ± 128 . This range (± 128) corresponds to about ± 12 seconds from the original point (ADJUST 0).

6 Press SET.

Playback continues.

```

HDD 2- 2
3:25
POSI.B?→SET
  
```

Within the first 4 seconds, this will not be shown.

By holding SELECT ►► or SELECT ◀◀, you can fast-forward or fast-reverse the track to find the end point.

- If you reach the end of the track while searching, you will go back to the start point (POS1.A).

7 Press SET again when you find the end point (POS1.B) for A-B copy.

The portion (of about 2-second length) following the selected end point repeats playing.

```

POSI.B
ADJUST 0
OK?→SET
  
```

- 8** If necessary, press SELECT ►► or SELECT ◀◀ to precisely adjust the end point.

The unit repeats the newly selected end point.

- You can shift the end point up to ± 128 . This range (± 128) corresponds to about ± 12 seconds from the original point (ADJUST 0).

- 9** Press SET.

Playback stops, and the library selection screen appears.

```

A-B COPY
Library 1
OK?→SET
  
```

The currently selected library flashes.

- 10** Press LIBRARY to select a library (“Library 1”—“Library 10”) you want to copy the selected album into, then press SET.

Album number is automatically assigned to a newly created album (the youngest unused number will be selected).

The confirmation screen appears in the main display.

```

A-B COPY      HDD 12- 1
Library 9     Library 9
OK?→SET     YES?→ENTER
  
```

Ex. When selecting “Library 9”

- 11** Press ENTER.

The HDD lamp flashes in red.

“PLEASE WAIT” then “HDD WRITING” appears while the editing you have made is being stored in the HDD.

- It takes a long time if you have copied a long portion.

Moving a Track—MOVE

You can move a track either within the same album or into a different album.

Tracks are automatically renumbered in both albums—where a track has been moved from and where the track has moved to.

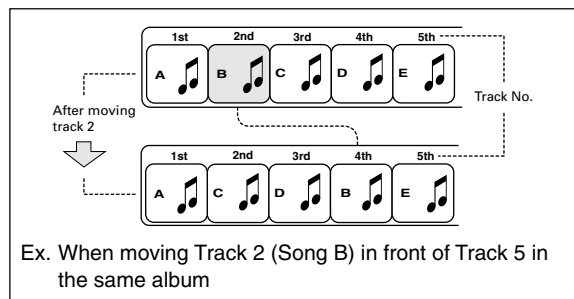

On the remote control ONLY:

If the HDD includes many albums and tracks, select the album and track using Search Mode (see page 34) before performing the procedure below.

- 1** Press TITLE/EDIT repeatedly until “TRACK EDIT?” appears in the main display, then press SET.

- The source changes to “HDD” automatically if another source has been selected.

```

TRACK EDIT? → TRACK EDIT
YES?→SET   COPY TRACK?
              OK?→SET
  
```

- 2** Press SELECT ►► or SELECT ◀◀ to select “MOVE?,” then press SET.

```

TRACK EDIT → MOVE FROM
MOVE?      HDD 2- 2
OK?→SET   OK?→SET
  
```

The currently selected track number of the current album flashes.

3 Select a track you want to move from.

- 1) Press **ALBUM +** or **ALBUM -** to select an album.
- 2) Press **SELECT ►►** or **SELECT ◄◄** to select a track.
 - You can select the track directly using the number buttons. In this case, the selected track starts playback repeatedly.
- 3) Press **SET**.

MOVE FROM HDD 5- 5- 5- → MOVE TO HDD 5- 1- 1-
 OK?→SET OK?→SET
 Ex. When moving Track 5 from Album 5

4 Select the position (track number) you want to move to.

- 1) Press **ALBUM +** or **ALBUM -** to select an album.
- 2) Press **SELECT ►►** or **SELECT ◄◄** to select the position (track number).
 - To move the track as the last track in the selected album, select “END.”
 - You can select the track directly using the number buttons. In this case, the selected track starts playback repeatedly.
- 3) Press **SET**.

MOVE TO HDD 9- 9- 9- → (MOVE) YES?→ENTER
 OK?→SET
 Ex. When moving into Album 9 as the last track

5 Press ENTER.

The HDD lamp flashes in red.
 “PLEASE WAIT” appears while the editing you have made is being stored in the HDD.

- If you have performed the above procedure during play, HDD playback stops.



If “CANNOT ENTRY LIB.” appears in the main display

You have selected the album in “Library TUNER,” or you have selected an album including 254 tracks (fully recorded album) in step 4.

You cannot move a track into such albums.

Dividing a Track—DIVIDE

This function separate a track into two tracks.

The subsequent tracks are automatically renumbered.

- When the original track has a title, two separate tracks are reassigned the same title as the original track.
- You cannot set a dividing point within the first 4 seconds and the last 3 seconds of a track.

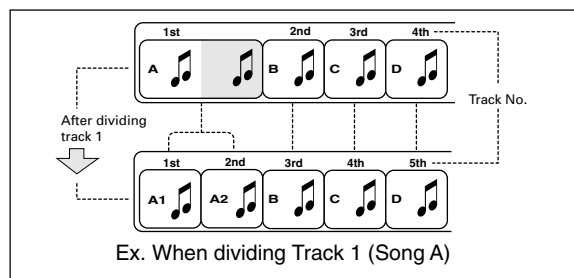

On the remote control ONLY:

If the HDD includes many albums and tracks, select the album and track using Search Mode (see page 34) before performing the procedure below.

1 Press TITLE/EDIT repeatedly until “TRACK EDIT?” appears in the main display, then press SET.

- The source changes to “HDD” automatically if another source has been selected.

TRACK EDIT? → TRACK EDIT COPY TRACK? →
 YES?→SET OK?→SET

2 Press SELECT ►► or SELECT ◄◄ to select “DIVIDE?,” then press SET.

The currently selected track starts playing.

TRACK EDIT HDD 2- 1
 DIVIDE? → 0:05
 OK?→SET TRK OK?→SET

Within the first 4 seconds, this will not be shown.

3 If necessary, select a track.

- 1) Press **ALBUM +** or **ALBUM -** to select an album.
- 2) Press **SELECT ►►** or **SELECT ◄◄** to select a track.
 - You can select the track directly using the number buttons.

By holding **SELECT ►►** or **SELECT ◄◄**, you can fast-forward or fast-reverse the track to find the dividing point.

4 Press SET when you find the dividing point.

The portion (of 2-second length) following the selected dividing point repeats playing.

```

DIVIDE
ADJUST 0
OK?→SET

```

5 If necessary, press SELECT ►► or SELECT ◄◄ to precisely adjust the dividing point.

The unit repeats the newly selected dividing point.

- You can shift the dividing point up to ± 128 . This range (± 128) corresponds to about ± 12 seconds from the original point (ADJUST 0).

6 Press SET.

Playback stops.

```

(DIVIDE)
YES?→ENTER

```

7 Press ENTER.

The HDD lamp flashes in red.

“PLEASE WAIT” appears while the editing you have made is being stored in the HDD.

- It takes a long time if you have divided a long track.

To join the divided tracks, see the JOIN function that follows.



If “CANNOT DIVIDE” appears in main display

- You cannot divide the track because the current album already include 254 tracks in it.
- You cannot divide the track recorded using Tuner Auto Recording.
- You cannot divide the track if there is not enough space left in the HDD. (When dividing a track, more space is required to be left in HDD rather than required for recording the separated tracks.)

Joining Tracks—JOIN

This function joins two adjacent tracks into a single track. The subsequent tracks are automatically renumbered.

- When two tracks have their own titles, the title of the preceding track is reassigned to the joined track.
- You cannot join the tracks in different albums or tracks recorded in different recording modes (ex. AAC 128kbps and Linear PCM).
- If you join some tracks recorded from a live CD, you will hear noise when playing back the joined portion. (To avoid this, use analog recording method on page 47, then join the tracks you want.)

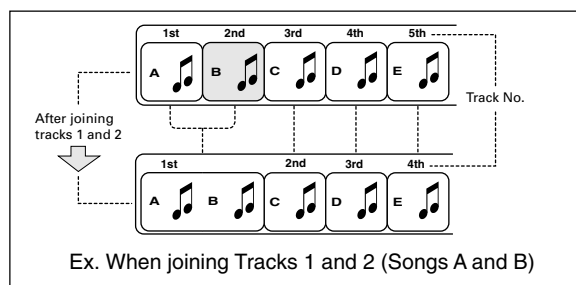

On the remote control ONLY:

If the HDD includes many albums and tracks, select the album and track using Search Mode (see page 34) before performing the procedure below.

1 Press TITLE/EDIT repeatedly until “TRACK EDIT?” appears in the main display, then press SET.

- The source changes to “HDD” automatically if another source has been selected.

```

TRACK EDIT? → TRACK EDIT
YES?→SET      COPY TRACK?
                OK?→SET

```

2 Press SELECT ►► or SELECT ◄◄ to select “JOIN?,” then press SET.

```

TRACK EDIT  HDD  2-  1
  JOIN? →  ---+  E?
  OK?→SET

```

Ex. When currently selected Album number appears with the current track number

3 Select two adjacent tracks you want to join.

- 1) Press **ALBUM +** or **ALBUM -** to select an album.
 - If the album you have selected includes only one track, you cannot go to the step below. Select another album including more than one track in it.
- 2) Press **SELECT ►►** or **SELECT ◄◄** to select tracks.
 - You can select a track (and its adjacent track) directly using the number buttons. In this case, the selected track starts playback repeatedly.
- 3) Press **SET**.

HDD 15- 2
1+ 2
OK?→SET → (JOIN)
YES?→ENTER

4 Press ENTER.

- The HDD lamp flashes in red.
“PLEASE WAIT” appears while the editing you have made is being stored in the HDD.
- If you have performed the above procedure during play, HDD playback stops.

To divide the joined tracks, see the **DIVIDE** function on page 60.



If “CANNOT JOIN” appears in the main display

- You cannot join the tracks because they are recorded in different recording modes.
- You cannot join tracks if the total playing time of the joined track becomes—more than 3 hours in the Linear PCM format, and more than 24 hours in AAC format.

Erasing a Track—ERASE TRK

You can erase an unwanted track one by one.
The subsequent tracks are automatically renumbered.

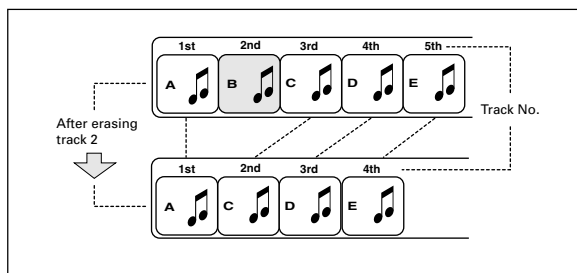

On the remote control ONLY:

If the HDD includes many albums and tracks, select the album and track using Search Mode (see page 34) before performing the procedure below.

1 Press TITLE/EDIT repeatedly until “TRACK EDIT?” appears in the main display, then press SET.

- The source changes to “HDD” automatically if another source has been selected.

TRACK EDIT? → TRACK EDIT
YES?→SET COPY TRACK? →
OK?→SET

2 Press SELECT ►► or SELECT ◄◄ to select “ERASE TRK?,” then press SET.

TRACK EDIT → ERASE TRK
ERASE TRK? → HDD 2- 1
OK?→SET OK?→SET

The currently selected track number of the current album flashes.

3 Select a track you want to erase.

- 1) Press **ALBUM +** or **ALBUM -** to select an album.
- 2) Press **SELECT ►►** or **SELECT ◄◄** to select a track.
 - You can select a track directly using the number buttons. In this case, the selected track starts playback repeatedly.
- 3) Press **SET**.

(ERASE TRK)
YES?→ENTER

4 Press ENTER.

“HDD WRITING” appears and the HDD lamp flashes in red while the editing you have made is being stored in the HDD.

- If you have performed the above procedure during play, HDD playback stops.



If you want to erase only a portion of a track

Use the **DIVIDE**, **ERASE**, then **JOIN** functions.
First divide a track into three portions (second portion must be the one you want to erase). Then erase the second portion, and finally join the first portion and the third portion.

Using the Timers

The buttons enlarged in the illustration below are used and explained in this section (pages 64 to 68).

Remote control

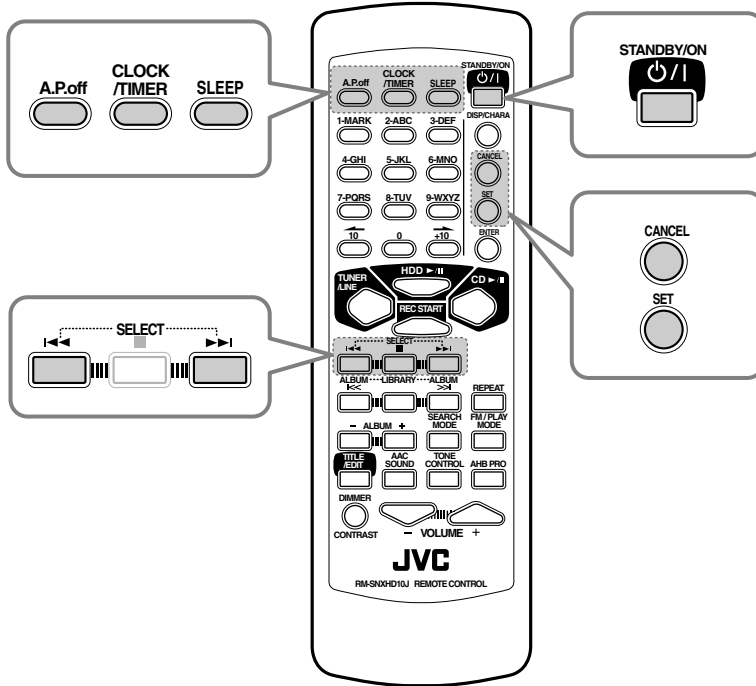

Front panel

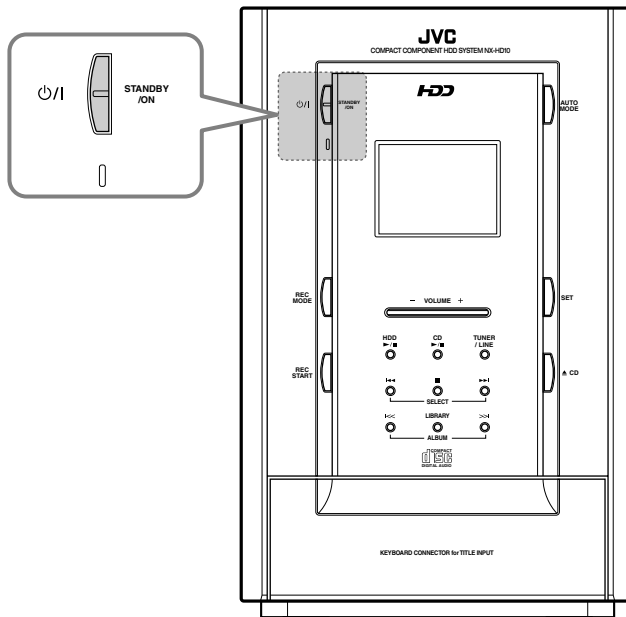

There are three timers available—Recording Timer, Daily Timer, and Sleep Timer. In addition, you can use Auto Power Off to turn off the unit automatically.

- When you use more than one timer, make sure to give the unit at least one-minute interval between timers; otherwise, the unit cannot start the timer with a later on-time.

Using Recording Timer

With Recording Timer, you can make an unattended recording. This unit can memorize three daily or weekly Recording Timer settings (Recording Timers 1, 2, and 3). You can set Recording Timer whether the unit is turned on or in standby mode.

- To return to the previous screen any time during the process, press CANCEL.

How Recording Timer actually works

“REC TIMER (with an active timer number) STANDBY” starts flashing in the main display about one minute before the timer on-time (the REC indicator and the timer number indicator also start flashing on the display). When the timer on-time comes, the unit starts recording into the HDD (no sound comes out during recording). Then, when the timer off-time comes, “REC TIMER OFF” flashes, and the unit automatically turns off (on standby). The recording is automatically assigned the youngest unused album number and is stored in “Library 1.”

- Recording Timer settings remain stored in memory until you reset them or unplug the AC power cord.

On the remote control ONLY:

1 Press CLOCK/TIMER repeatedly until “REC TIMER SET UP” appears in the main display.

The REC (Recording Timer) indicator and the number indicator for the currently selected timer start flashing on the display. Then the timer number also starts flashing in the main display.

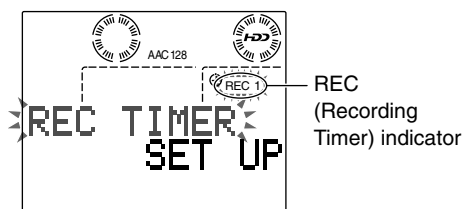

REC TIMER 1
OK?>SET

2 Press SELECT >>> or SELECT <<< to select the timer number (REC TIMER 1, 2, or 3) you want to use, then press SET.

The day-of-the-week setting screen appears.

REC TIMER 2
DAY Mon
OK?>SET

Ex. When selecting “REC TIMER 2”

3 Press SELECT >>> or SELECT <<< to select the day of the week you want to perform the timer recording.

- Each time you press the button, the day-of-the-week settings change as follows:

Mon (Monday) <> Tue (Tuesday) <>
Wed (Wednesday) <> Thu (Thursday) <>
Fri (Friday) <> Sat (Saturday) <> Sun (Sunday) <>
Sat-Sun <> Mon-Fri <> Mon-Sat <> Every <>
(to the beginning)

REC TIMER 2
DAY Mon-Fri
OK?>SET

Ex. When selecting “Mon (Monday)– Fri (Friday)”

- When you select a week day (“Monday” to “Sunday”), the recording timer works at the set time on the same day weekly.
- When you select “Sat-Sun,” the recording timer works at the set time both on Saturday and Sunday every week.
- When you select “Mon-Fri,” the recording timer works at the set time on Monday through Friday.
- When you select “Mon-Sat,” the recording timer works at the set time on Monday through Saturday.
- When you select “Every,” the recording timer works at the set time every day.

4 Press SET.

The timer on-time setting screen appears.

- If you have set the timer before, the previously set timer on-time will appear (instead of “--:--”).

REC TIMER 2
ON AM --:--
OK?>SET

5 Set the timer on-time.

- 1) Press SELECT ►► or SELECT ◀◀ to adjust the hour, then press SET.

The minute digit starts flashing.

- 2) Press SELECT ►► or SELECT ◀◀ to adjust the minute, then press SET.

The timer off-time setting screen appears.

- If you have set the timer before, the previously set timer off-time will appear (instead of “-- : --”).

```
REC TIMER 2
OFF AM--:--
OK?→SET
```

6 Set the timer off-time.

- 1) Press SELECT ►► or SELECT ◀◀ to adjust the hour, then press SET.

The minute digit starts flashing.

- 3) Press SELECT ►► or SELECT ◀◀ to adjust the minute, then press SET.

The recording source setting screen appears.

```
REC TIMER 2
FM?
OK?→SET
```

7 Select the source to record from.

- 1) Press SELECT ►► or SELECT ◀◀ to select the source.

- Each time you press the button, the sources change as follows:

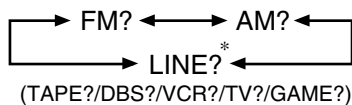

- * If you have changed the source names, the changed names will appear in the main display (see page 22).

- 2) Press SET.
- 3) When you select “FM?” or “AM?” as the source, press SELECT ►► or SELECT ◀◀ again to select a preset channel number, then press SET.
 - If you select “--,” the currently received station will be tuned in.

When you select the external component as the playback source, prepare the external component with the timer function.

The recording mode setting screen appears.

- 8 Press SELECT ►► or SELECT ◀◀ to select the recording mode—“AAC128 REC?” or “AAC 96 REC?,” then press SET.

The REC indicator and the timer number indicator stop flashing and remain lit on the display.

```
REC TIMER 2
AAC128 REC?
OK?→SET
```

The contents of this setting are shown in sequence.

Ex. When selecting “AAC128 REC?”

- For each recording mode, see page 39.

- 9 Press STANDBY/ON to turn off the unit if necessary.

To turn off the Recording Timer after its setting is done

- 1 Press CLOCK/TIMER once.

The currently selected Recording Timer ON/OFF setting screen appears in the main display.

```
REC TIMER 2
ON?→SET
OFF?→CANCEL
```

Ex. When Recording Timer 2 is currently selected

- 2 Press SELECT ►► or SELECT ◀◀ to select the timer number (REC TIMER 1, 2 or 3) you want.
- 3 Press CANCEL.

The selected Recording Timer will be turned “OFF,” and the timer number indicator goes off from the display. (If the other two Recording Timer settings have been also turned off, the REC indicator also goes off.)

To turn on the Recording Timer, repeat steps 1 and 2, and press SET in step 3.

The REC indicator and the timer number indicator for the currently selected timer light up on the display. The settings you have stored are shown in the main display for your confirmation.

- “REC TIMER (with the current timer number) NO SET” appears and “SET REC!” flashes in the main display if no timer setting has been done for the currently selected Recording Timer.



If recording is performed when the timer on-time comes

Recording Timer does not work at all.



If you press CLOCK/TIMER, SLEEP, or TITLE/EDIT during timer recording

Recording Timer is canceled temporarily. Recording continues, but the unit will not turn off when the timer off-time comes.

- If you press or turn off the unit, recording stops.

Using Daily Timer

With Daily Timer, you can wake up to your favorite music or radio program.

You can set Daily Timer whether the unit is turned on or in standby mode.

- To return to the previous screen any time during the process, press CANCEL.

How Daily Timer actually works

“DAILY TIMER STANDBY” starts flashing in the main display about one minute before the timer on-time (the DAILY indicator also starts flashing). When the timer on-time comes, the unit starts playing the specified source at the specified volume level. Then, when the timer off-time comes, “DAILY TIMER OFF” flashes, and the unit automatically turns off (on standby).

- Daily Timer setting remains stored in memory until you reset it or unplug the AC power cord.

On the remote control ONLY:

- Press CLOCK/TIMER repeatedly until “DAILY TIMER SET UP” appears in the main display. The DAILY indicator starts flashing on the display.

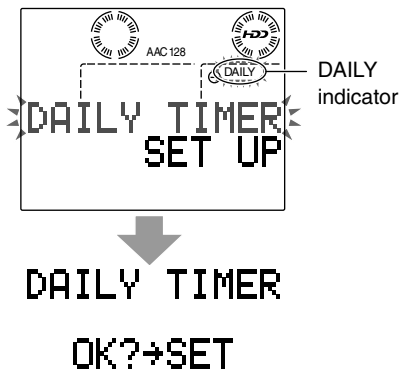

- Press SET.

The timer on-time setting screen appears. The hour digit of the timer on-time starts flashing.

- If you have set the timer before, the previously set timer on-time will appear (instead of “-- : --”).

DAILY TIMER
ON AM -- : --
OK?>SET

- Set the timer on-time.

- Press SELECT ►► or SELECT ◀◀ to adjust the hour, then press SET.
The minute digit starts flashing.
- Press SELECT ►► or SELECT ◀◀ to adjust the minute, then press SET.
The timer off-time setting screen appears.

- Set the timer off-time.

- Press SELECT ►► or SELECT ◀◀ to adjust the hour, then press SET.
The minute digit starts flashing.

- Press SELECT ►► or SELECT ◀◀ to adjust the minute, then press SET.

The playback source setting screen appears.

DAILY TIMER
OK?>SET

- Select the source to play.

- Press SELECT ►► or SELECT ◀◀ to select the source.

- Each time you press the button, the sources change as follows:

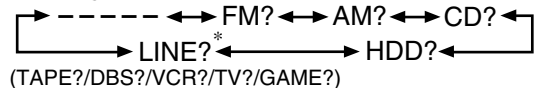

- * If you have changed the source names, the changed names will appear in the main display (see page 22).

- Press SET.

- When you select “----,” the unit starts playing the last selected source when the unit is turned off.

When you select “FM?” or “AM?,” press SELECT ►► or SELECT ◀◀ again to select a preset channel number, then press SET.

- If you select “--,” the last received station will be tuned in.

When you select “CD?,” press SELECT ►► or SELECT ◀◀ again to select a track you want to start playback with, then press SET.

- If you select “--,” playback starts with the first track.

When you select “HDD?,”

- Press SELECT ►► or SELECT ◀◀ to select an album, then press SET.
 - If you select “--,” the last played album will be selected.
- Press SELECT ►► or SELECT ◀◀ to select a track, then press SET.
 - If you select “--,” playback starts with the first track of the last selected album.

When you select the external component (such as “LINE”), prepare an external equipment with the timer function.

The volume setting screen appears.

- 6** Press SELECT ►► or SELECT ◀◀ to adjust the volume level, then press SET.
- You can adjust the volume level within the range of 0 (silent) to 50 (maximum).
 - When you select “VOL. – –” (selectable only with the unit turned on), the volume is set to the current level.

- 7** Press SELECT ►► or SELECT ◀◀ to select “FADE” or “NoFADE”, then press SET.

- FADE** : Volume fades in (gradually becomes louder and is set to the specified level).
- NoFADE** : No fade-in effect. Volume is set to the specified level when the timer on-time comes.

The DAILY indicator stops flashing and remains lit on the display.

The contents of this setting appear in sequence.

- 8** Press STANDBY/ON  to turn off the unit.

To turn off the Daily Timer after its setting is done

- 1** Press CLOCK/TIMER three times.

The Daily Timer ON/OFF setting screen appears in the main display.

DAILY TIMER
ON?→SET
OFF?→CANCEL

- 2** Press CANCEL.

The Daily Timer will be turned “OFF,” and the DAILY indicator goes off from the display.

To turn on the Daily Timer, repeat step 1, and press SET in step 2.

The DAILY indicator lights up on the display. The settings you have stored are shown in the main display for your confirmation.

- “DAILY TIMER NO SET” appears and “SET DAILY!” flashes in the main display before you enter the timer settings.



If the unit is turned on when the timer on-time comes

Daily Timer does not work at all.



If you change the source or turn off the unit while Daily Timer is working

Daily Timer is canceled temporarily.



If you press CLOCK/TIMER, SLEEP, or TITLE/EDIT during timer recording

Daily Timer is canceled temporarily, and the unit will not turn off when the timer off-time comes.

Using Sleep Timer

With Sleep Timer, you can fall asleep to your favorite music.

You can set Sleep Timer when the unit is turned on.

How Sleep Timer actually works

The unit automatically turns off after the specified time length passes.

On the remote control ONLY:

Press SLEEP until the shut-off time you want appears.

The SLEEP indicator lights up on the display.

The HDD lamp and the VOLUME lamp on the front panel also go off.

“SLEEP” and sleep time appear in the main display.

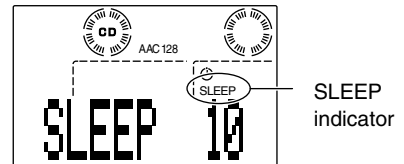

- Each time you press the button, the time length changes as follows:

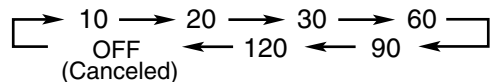

- If the built-in clock has not been set, “CLOCK ADJUST!” will flash for a while.

The display dims when the sleep timer starts working.

To check the remaining time until the shut-off time, press SLEEP once. The remaining time until the shut-off time appears in the main display for about 5 seconds.

To change the shut-off time, press SLEEP repeatedly until the time length you want appears.

To cancel the setting, press SLEEP repeatedly until “SLEEP OFF” appears in the main display.



Sleep Timer will be also canceled in the following cases:

- When the unit is turned off,
- When Recording timer is operated, and
- When the clock or any other timer is readjusted.

To sleep with Sleep Timer and wake up with Daily Timer

The unit turns off when the shut-off time comes (set by the Sleep Timer), and turns on when the timer on-time (set by the Daily Timer) comes.

- 1 Set Daily Timer as explained on page 66.
- 2 Start playing back any source you want to listen to before sleep.
- 3 Set Sleep Timer.

Using Auto Power Off

Auto Power Off automatically turns off the unit if no sound comes in for more than 3 minutes except when FM or AM is selected as the source.

If some operation is done during this 3-minute period, Auto Power Off is canceled temporarily even though no sound comes in.

On the remote control ONLY:

To activate Auto Power Off, press A.P.off.

The A.P.off indicator lights up on the display and “A.P.off SET” appears in the main display.

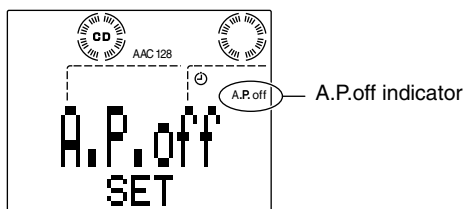

- When no sound comes in, the A.P.off indicator starts flashing on the display. About 20 seconds before the unit turns itself off, it starts counting down the time.

A.P.off
Count Down
20sec

To deactivate Auto Power Off, press A.P.off.

The A.P.off indicator goes off from the display and “A.P.off CANCEL” appears in the main display.



When Recording Timer or Daily Timer starts working

Auto Power Off will not turn off the unit.

Timer Priority

Since each timer can be set separately, you may wonder what happens if the setting for these timers overlaps. Here are the priorities for each timer.

- If Recording Timer (1, 2, or 3) and the other two timers—Daily Timer and Sleep Timer overlap, Recording Timer has priority over the others.

If Recording Timer is set to come on while Daily Timer is operating, Daily Timer is canceled.

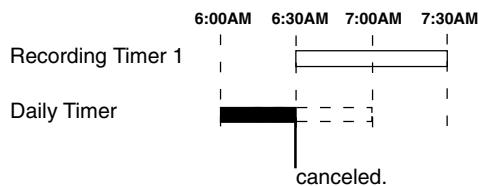

If Recording Timer is set to come on while Sleep Timer is operating, Sleep Timer will not turn off the unit even if the shut-off time comes.

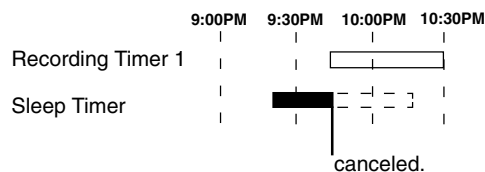

- If two Recording Timers overlap, a timer with an earlier on-time has priority over the other.

A timer with a later on-time will be canceled on that particular day. (For example, if the timer with an earlier on-time is set to work only on Monday but the other timer with a later on-time is set to work every day, the other timer will not work on Monday.)

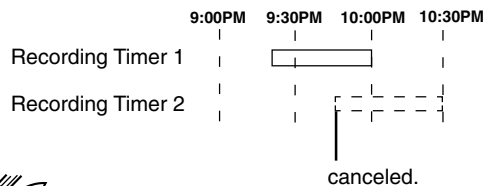

More on Recording Timers and Daily Timer

If the timer off-time of one timer (say, Timer A) and the timer on-time of another (Timer B) are set so close (one minute or less apart), Timer B will be canceled temporarily even though they are not overlapped.

Sleep Timer and Auto Power Off can be used at the same time.

Using an Optional Keyboard

You can connect a keyboard with the PS/2 plug to the KEYBOARD terminal inside the front door (see page 9). You can use the following keys to operate this unit for Edit and Search Modes.

- You can use such a keyboard as a PS/2 US101 keyboard or an equivalent. However, the keyboard connected to this unit must be a type of **DC 5 V and less than 100 mA**.

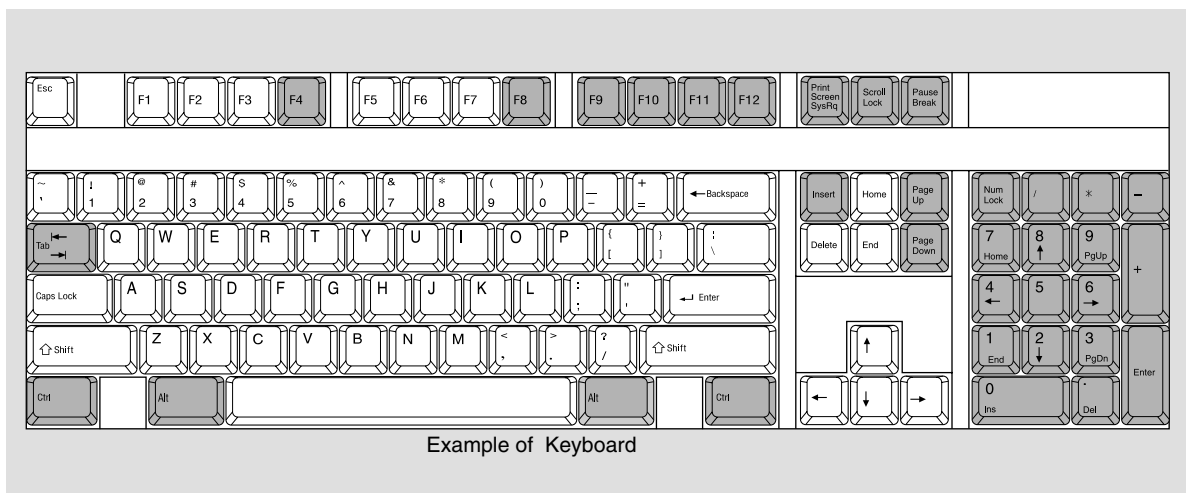

Keys Used for Operating This Unit



- F1** : Enter Album Title Edit Mode (see page 70).
Press again to exit from Edit Mode.
- F2** : Enter Track Title Edit Mode (see page 70).
Press again to exit from Edit Mode.
- F3** : Enter Library Name Edit Mode (see page 71).
Press again to exit from Edit Mode.
- F5** : Enter Album Number Search (see page 71).
Press again to exit from Search Mode.
- F6** : Enter Album Title Search (see page 71).
Press again to exit from Search Mode.
- F7** : Enter Track Title Search (see page 71).
Press again to exit from Search Mode.
- Esc** : Exit from the above Edit and Search Modes.

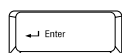

(Enter)

- : Functions in the same way as the SET and ENTER buttons on the remote control.



- : **While selecting a library**, used to select library numbers.

- : **While selecting an album**, functions in the same way as the ALBUM + / - buttons on the remote control.

- : **While selecting a track**, functions in the same way as the SELECT ◀◀ / ▶▶ buttons on the remote control.

- : **While entering a title**, functions in the same way as the ◀ / ▶ buttons on the remote control.



- : **During Album Number Search**, used to select the last album number by the cursor upward button (↑), and the first album number (1) by the cursor downward button (↓).



(Delete)

- : Deletes unnecessary characters on the cursor position.



(Back Space)

- : Deletes unnecessary characters in front of the cursor position.



(Home)

: Moves the cursor at the beginning of the title entry screen.



(End)

: Moves the cursor at the end of the title entry screen.

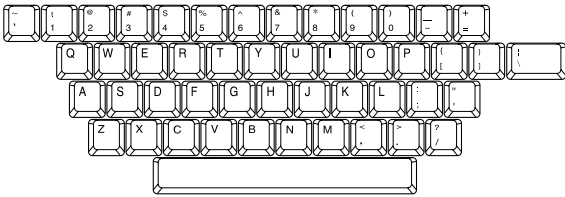

Alphabet keys, 10 keys, Symbol keys, and Space bar
: Used to enter letters, numbers, symbols and spaces.

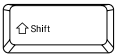

(Shift)

: Used to enter capital letters and upper symbols on some of the keys.



(Caps Lock)

: Used to always enter capital letters. When Caps Lock is in use, the CAPS indicator on the display lights up. (The CAPS indicator on the connected keyboard will not light up—this is normal.)



When disconnecting the keyboard

Make sure that the CAPS indicator on the display is not lit.

- The CAPS indicator on the display will turn off when the unit is turned off then on.

Operating Procedures Using the Keyboard

While using the keyboard, the character set indication shown in the main display will not change even when you enter small letters or numbers.

To assign an album title—F1

See also “To assign a title to an album” on pages 49 to 50.

- 1 Press F1 so that the following screen appears in the main display.

TITLE
ALBUM 3?
OK?→SET

Currently selected album number appears first.

- 2 Press → or ← to select an album number, then press ↵ Enter.

TITLE
ALBUM 19?
OK?→SET

ALBUM 19
a 1

Character entry position

Character set

Ex. When selecting “Album 19”

- 3 Enter a title, then press ↵ Enter.

The track title entry screen appears (you can go to step 2 of the procedure below).

- If you are recording, the unit exits from Album Title Edit mode.

To assign a track title—F2

See also “To assign titles to tracks” on page 50.

- 1 Press F2 so that the following screen appears in the main display.

TITLE
TRACK 9?
OK?→SET

Currently selected track number of the current album appears first.

- 2 Press → or ← to select a track number, then press ↵ Enter.

TITLE
TRACK 12?
OK?→SET

TRACK 12
a 1

Character entry position

Character set

Ex. When selecting “Track 12”

- 3 Enter a title, then press ↵ Enter.

The next track title entry screen appears.

- If you are recording, the unit exits from Track Title Edit mode.

To change a library name—F3

See also “Changing the Library Names—LIB. NAME” on page 53.

- 1 Press F3 so that the following screen appears in the main display.

```
LIB. NAME
Library 3
OK?→SET
```

Currently selected library appears.

- 2 Press → or ← to select a library number, then press ← Enter.

```
LIB. NAME      Library 9
Library 9      Library 9
OK?→SET      [ a 1 ]
```

Character entry position Character set

Ex. When selecting “Library 9”

- 3 Press Delete repeatedly until the previous name is completely erased.

- 4 Enter a new name, then press ← Enter. “HDD WRITING” appears and the HDD lamp flashes in red while the editing you have made is being stored in the HDD.

- If you have performed the above procedure during play, HDD playback stops.

To search for an album by its number—F5

See also “To search for an album by its number—ALBUM No.” on page 34.

- 1 Press F5 so that the following screen appears in the main display.

```
ALBUM No.
[ a 1 ]
OK?→ENTER
```

- 2 Press 10 keys to select a track number, then press ← Enter.

The selected album starts playing in Continuous play.

```
ALBUM No.  HDD 24- 1
>24:00:01
OK?→ENTER Library 2
```

Ex. When selecting album 24

Ex. For album number 5, press 5, then ← Enter.
For album number 10, press 1, 0, then ← Enter.
For album number 204, press 2, 0, 4 then ← Enter.

For album number 1, press the cursor downward button (↓), then ← Enter.

For the last album number, press the cursor upward button (↑), then ← Enter.

To search for an album by entering its title—F6

See also “To search for an album or a track by entering its title—ALBUM T./TRACK T.” on pages 35 and 36.

- 1 Press F6 so that the following screen appears in the main display.

```
ALBUM TITLE
[ a 1 ]
```

Character set
Character entry position

- 2 Enter a title (up to 5 characters), then press ← Enter. “SEARCH” starts flashing in the main display. The unit starts searching for the title.

To search for a track by entering its title—F7

See also “To search for an album or a track by entering its title—ALBUM T./TRACK T.” on pages 35 and 36.

- 1 Press F7 so that the following screen appears in the main display.

```
TRACK TITLE
[ a 1 ]
```

Character set
Character entry position

- 2 Enter a title (up to 5 characters), then press ← Enter. “SEARCH” starts flashing in the main display. The unit starts searching for the title.

Maintenance

To get the best performance of the unit, keep your CDs and mechanism clean.

General Notes

In general, you will have the best performance by keeping your CDs and the mechanism clean.

- Store CDs in their cases, and keep them in cabinets or on shelves.
- Keep the CD tray closed when not in use.

Handling CDs



- Remove the CD from its case by holding it at the edge while pressing the center hole lightly.
- Do not touch the shiny surface of the disc, or bend the CD.
- Put the CD back in its case after use to prevent warping.

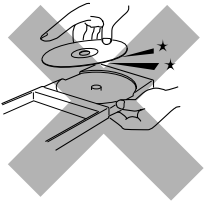

- Be careful not to scratch the surface of the CD when placing it back in its case.
- Avoid exposure to direct sunlight, temperature extremes, and moisture.



To clean the CD

Wipe the CD with a soft cloth in a straight line from center to edge.



DO NOT use any solvent—such as conventional record cleaner, spray, thinner, or benzine—to clean the CD.

Cleaning the unit

• Stains on the unit

Should be wiped off with a soft cloth. If the unit is heavily stained, wipe it with a cloth soaked in water-diluted neutral detergent and wrung well, then wipe clean with a dry cloth.

• Since the unit may deteriorate in quality, become damaged or get its paint peeled off, be careful about the following.

- DO NOT wipe it with a hard cloth.
- DO NOT wipe it strong.
- DO NOT wipe it with thinner or benzine.
- DO NOT apply any volatile substance such as insecticides to it.
- DO NOT allow any rubber or plastic to remain in contact with it for a long time.

Messages

For HDD:

Message	Signification	Solution
ALBUM No. FULL	No more album can be additionally made.	Erase unnecessary albums from the HDD. (The maximum number of the albums is 999.)
CANNOT DIVIDE	<ul style="list-style-type: none"> You are trying to divide a track (album) recorded in "Library TUNER." You have already 254 tracks recorded in the album. 	<ul style="list-style-type: none"> This is not a malfunction. This track cannot be divided. Erase unnecessary tracks from the album. (The maximum number of the tracks in an album is 254.)
CANNOT EDIT! (or REC!) LOW TEMP	The room temperature is too low for the operation.	This is not a malfunction. You can perform the operation only at a temperature between 5°C (41°F) to 35°C (95°F).
CANNOT ENTRY LIB.	You are trying to store an album in a full library.	More than 100 albums cannot be stored in a library. Select another library.
CANNOT ENTRY LIB. Library TUN	You are trying to copy a track into an album of "Library TUNER."	Select another album.
CANNOT JOIN	You are trying to join tracks which cannot be joined.	This is not a malfunction (see pages 62).
CANNOT LISTEN!	You are trying to listen to the sound during high-speed recording.	This is not a malfunction. You cannot adjust the sound during high-speed recording.
CANNOT REC! HDD FULL	You are trying to record when there is no more space in the HDD.	Erase unnecessary albums or tracks from the HDD. Then try again.
EMERGENCY STOP	Something is wrong with the HDD and recording has stopped.	Try to record one more time. If the trouble still persists, consult your dealer.
EMERGENCY YES? → SET	AC power supply has been interrupted while recording, compressing (Smart Compression) or editing the data in the HDD. (For example, a power failure has occurred or AC power cord is unplugged.)	Follow the instructions shown in the main display—perform the REBUILD function (see "How to rebuild the HDD" on the next page for details). If the trouble still persists, erase all data using the ALL ERASE function (see page 57).
HDD FULL	There is no more space in the HDD.	Erase unnecessary albums from the HDD.
NON-AUDIO CANNOT COPY	You are trying to record a non-audio file into the HDD.	Change the source disc.
NOT AAC	You are trying to apply an AAC sound mode to non-AAC encoded tracks.	Change the track.
NOT FOUND	After searching for an album or a track by its name, no album or track is found.	Use another search mode (see page 34).
SCMS CANNOT COPY	You are trying to record the 2nd generation digital source.	Analog recording will be automatically selected (see page 39).
TRACK No. FULL	No more track can be additionally made in the current album.	Erase unnecessary tracks from the album. (The maximum number of the tracks in an album is 254.)

For CD:

Message	Signification	Solution
ALL SKIP TRK.	All the tracks on the disc have a Track Skip mark*.	Change the disc.
CANNOT PLAY	You are trying to play back a CD which cannot be played, or there is a problem with the CD.	Change the disc.
CD1 SKIP TRK.	The first track on the CD has a Track Skip mark.	Wait for a while until the unit finds another track without a Track Skip mark.
CD NO DISC	There is no disc loaded on the CD tray.	Place a disc.
CD PROGRAM CANNOT x4 RECORDING!	You are trying to use x4 speed recording method to record a CD program play.	Use another recording method.
CD RANDOM CANNOT x4 RECORDING!	You are trying to use x4 speed recording method to record a CD random play.	Use another recording method.
UNFINALIZE	You are trying to play back a CD-R/RW which has not been "finalized."	This is not a malfunction.

* Some CD-Rs and CD-RWs have Track Skip marks recorded. If this mark is recorded to a track, it is always skipped. This unit cannot record or erase these Track Skip marks.

How to rebuild the HDD

If "EMERGENCY / YES? → SET" appears in the main display, follow the procedure below.

1 Press SET.

"REBUILD?" starts flashing in the main display.

- If you want to erase all the data recorded now, press **SELECT** ►► or **SELECT** ◄◄ so that "ALL ERASE?" appears in the main display (each time you press the button, "REBUILD?" or "ALL ERASE?" alternately appears), then press **SET**. Then follow steps **3** to **5** on page 57 ("Erasing All Albums—ALL ERASE").

2 Press SET again.

"REBUILDING!" appears in the main display and the unit starts rebuilding the HDD contents.

- It may take a long time to rebuild the HDD when many albums and tracks have been recorded.

If the trouble still persists, erase all data using the ALL ERASE function (see page 57).



After you have rebuilt the HDD, the following symptom may be observed.

- Library names you have assigned may be reset to the original names.
- All albums in the HDD may be renumbered newly and will be relocated in libraries.
- Some albums or track may be erased from the HDD. These are required to normalize the HDD, and are not malfunctions.

Troubleshooting

If you are having a problem with your unit, check this list for a possible solution before calling for service.

If you cannot solve the problem from the hints given here, or the unit has been physically damaged, call a qualified person, such as your dealer, for service.

IMPORTANT: Before calling for service, make sure you have all data in the HDD duplicated into other recording devices, for it may be required to erase all data in the HDD for service purpose.

	Symptom	Possible Cause	Action
FM/AM	Poor radio reception.	<ul style="list-style-type: none"> The antenna is not connected correctly. The AM loop antenna is too close to the unit. The FM antenna is not properly extended and positioned. 	<ul style="list-style-type: none"> Reconnect the antenna securely. Change the position and direction of the AM loop antenna. Extend FM antenna to the best reception position.
	Stereo effect is lost in FM broadcast.	FM reception mode is changed to "FM MONO."	Press FM/PLAY MODE to select "FM AUTO" (see page 18).
CD playback	Loaded disc cannot be ejected.	<ul style="list-style-type: none"> The main AC power cord is not plugged in. The Disc Lock function is in use. 	<ul style="list-style-type: none"> Plug in the AC power plug. Turn off the Disc Lock function (see page 27).
	The disc does not play.	<ul style="list-style-type: none"> The disc is upside down. Track Skip mark is recorded for the first track of the disc. 	<ul style="list-style-type: none"> Put the disc in with the label side up. Wait until the unit finds a track without a Track Skip mark.
	Tracks are skipped.	<ul style="list-style-type: none"> The disc is dirty or scratched. Track Skip marks are recorded. 	<ul style="list-style-type: none"> Clean or replace the disc (see page 72). This is normal.
	Some of the CD functions, such as skip or search, do not work correctly.	You are playing an unfinalized disc.	This is normal. If you need to use these functions, finalize the disc. (This unit cannot finalize CD-Rs/CD-RWs.)
HDD playback	Sounds are skipped intermittently.	<ul style="list-style-type: none"> The unit is subject to external vibration or shock. If you have recorded the tracks from a live CD, sounds may be interrupted at the beginning of each track. 	<ul style="list-style-type: none"> Reduce the volume (speaker output level) or change the installation place. This is normal for the HDD. To avoid this, use analog recording, then join the tracks later using the JOIN function (see page 47 and 61).
	Search is not performed properly.	Search is performed on an AAC track of less than 20 seconds long.	This is normal.
	A library cannot be selected.	No album or track is recorded in the library.	Unless some recording is stored in a library, you cannot select it.
	Some albums or tracks cannot be selected.	Library information stored in the HDD and what actually recorded do not match. This may be caused by a power failure while recording, compressing (Smart Compression) or editing the data in the HDD.	Use the RESTORE function (see page 54).

	Symptom	Possible Cause	Action
HDD recording	Unable to record into HDD.	Already 999 albums are created in the HDD.	Erase unnecessary albums.
	CD Auto Recording cannot be done correctly.	<ul style="list-style-type: none"> You have stopped the playback before the entire disc is played back. Some of the tracks on the disc are copy-protected. 	<ul style="list-style-type: none"> This is normal. (For details, see page 41.) Use analog recording method (see page 47).
	CD Auto Recording does not start.	<ul style="list-style-type: none"> You have turned on the function after you started CD playback. CD play is started by Daily Timer . 	<ul style="list-style-type: none"> To use CD Auto Recording, stop playback, then restart CD playback. CD Auto Recording starts. This is normal.
	Tuner Auto Recording does not start.	FM or AM station is tuned in by Daily Timer or Recording Timer.	This is normal.
	Smart Compression is canceled.	You have pressed STANDBY/ON \odot /I while Smart Compression is performed.	The unit now goes into standby mode.
	Some mechanical noises are heard during Smart Compression.	While Smart Compression is being performed, the internal hard disk is still rotating at a high speed, causing imperceptible mechanical noises.	This is normal.
	If “Level OVER!” appears in the main display.	Recording (input) level through the external component is too high.	Adjust the input level (see page 21).
HDD editing	You can erase albums or tracks, but cannot use other editing functions such as “COPY,” “MOVE,” etc.	There is no space left in the HDD—“HDD FULL.”	This is normal. To use other editing functions, first erase unnecessary albums and tracks to make enough space in the HDD.
	You cannot copy a portion from a track—“A-B COPY.”	You have tried to copy a portion of a track of less than 6 seconds long.	This is normal. You cannot set a start point within the first second and set an end point within the last 5 seconds of a track (see page 58).
	You cannot move a track—“MOVE.”	You have tried to move a track to exactly the same position where it now located.	Select another track number as the position to move the track to.
	Tracks cannot be divided.	<ul style="list-style-type: none"> Already 254 tracks are created in the album. You have tried to divide the track (album) in “Library TUNER.” You have tried to divide a track of less than 7 seconds long. 	<ul style="list-style-type: none"> The maximum number of the tracks in an album is 254. Erase unnecessary tracks. You cannot divide this track. To divide this, copy this track to another library. You cannot set a dividing point within the first 4 seconds and the last 3 seconds of a track.

	Symptom	Possible Cause	Action
HDD editing	Tracks cannot be joined.	<ul style="list-style-type: none"> • These tracks are recorded in different recording modes or in different albums. • The total playing time of the joined track exceeds 3 hours in the Linear PCM format or 24 hours in the AAC format. 	<ul style="list-style-type: none"> • This is normal. You cannot join these tracks. • This is normal. The total playing time of a track cannot exceed these hours.
	When playing back the joined portion, you will hear noise.	You have joined some tracks recorded from a live CD.	If the tracks have been recorded digitally, this cannot be avoided. To avoid this, use analog recording method when recording these tracks (see page 47). Then join them later.
General	Mechanical noises are heard and the cabinet slightly vibrates.	The hard disk is constantly rotating at a high speed when the power is on, causing imperceptible mechanical noises and cabinet vibration.	This is normal.
	No sound is heard.	Connections are incorrect or loose.	Check all connections and make corrections (see pages 6 to 9).
	Unable to operate the remote control.	<ul style="list-style-type: none"> • The path between the remote control and the remote sensor on the unit is blocked. • The batteries have lost their charge. • You are using the remote control far from the main unit. 	<ul style="list-style-type: none"> • Remove the obstruction. • Replace the batteries (see page 9). • Signals cannot reach the remote sensor. Move closer to the main unit.
	If “ERROR” appears in the main display.	Something is wrong with your unit.	Unplug the unit immediately, then consult your dealer.
	If “ERROR! SPK DC OUT” appears in the main display and no sounds come from the speaker.	The volume is too high.	Turn off the unit and unplug it, then consult your dealer.
	External keyboard does not work at all.	The keyboard is not fully discharged electrically.	Turn off the unit, then turn it on back again after a while.
	Operations are disabled.	The built-in microprocessor has malfunctioned due to external electrical interference.	Press REC START and ▲ CD on the unit at the same time, or unplug the unit then plug it back in. (See “CAUTION” below.)



DO NOT press REC START and ▲ CD on the unit at the same time, or do not unplug the unit then plug it back in while recording, compressing (Smart Compression) or editing the data in the HDD; otherwise, the data will be damaged.

Specifications

Amplifier

Output Power:

25 W per channel, min. RMS, driven into 4 Ω from 40 Hz to 20 kHz, with no more than 10% total harmonic distortion

Audio input sensitivity/Impedance (at 1 kHz)

LINE IN : 260 mV/54 kΩ (at “LEVEL 1”)
640 mV/54 kΩ (at “LEVEL 2”)

Audio output level/Impedance (at 1 kHz)

LINE OUT : 215 mV/3.9 kΩ

Speakers/Impedance: 4 Ω to 16 Ω

Tuner

FM tuning range : 87.5 MHz to 108.0 MHz

AM tuning range : 530 kHz to 1 710 kHz

CD player

CD Capacity : 1 CD

Dynamic range : 88 dB

Signal-to-noise ratio : 95 dB

Wow and flutter : Immeasurable

Hard Disc Drive (HDD)

Data storage : 10 Gbytes

Recording system : Linear PCM
AAC 128 kbps
AAC 96 kbps

Recording length:

Linear PCM : Approx. 15 hours
AAC 128 kbps : Approx. 160 hours
AAC 96 kbps : Approx. 220 hours

General

Operating temperature : 5°C (41°F) to 35°C (95°F)

Operating altitude : -300 m to +3 048 m
(- 98 ft to +1 000 ft)

Power requirement : AC 120V~, 60 Hz

Power consumption : 55 W (in operation)
1.0 W (on standby: with display off)
1.2 W (on standby: with display on)

Dimensions (W/H/D) (approx.) :

150 mm x 237 mm x 274 mm
(5 ¹⁵/₁₆ in. x 9 ³/₈ in. x 10 ¹³/₁₆ in.)

Mass (approx.) : 4.8 kg (10.6 lbs)

Speaker system—SP-NXHD10

Type: 2-way bass-reflex type

Speakers:

Woofer : 10.0 cm (3 ¹⁵/₁₆ in.) cone x 1

Tweeter : 2.0 cm (¹³/₁₆ in.) dome x 1

Power handling capacity : 25 W

Impedance : 4 Ω

Frequency range : 52 Hz to 20 000 Hz

Sound pressure level : 82 dB/W·m

Dimensions (W/H/D) (approx.) :

125 mm x 237 mm x 239 mm
(4 ¹⁵/₁₆ in. x 9 ³/₈ in. x 9 ⁷/₁₆ in.)

Mass (approx.) : 2.3 kg (5.1 lbs) each

Supplied accessories

See page 6.

Design and specifications are subject to change without notice.

IMPORTANT: The manufacturer assumes no liability whatsoever for any damage resulting from missed opportunity or accidental erasure due to malfunctioning of the unit or due to trouble in the unit, such as fatal collapse of the hard disk drive itself.

- Since the HDD has its lifetime, it is strongly recommended to make a copy of your important recordings, and keep it using other recording devices.

Authorized Service Centers

QUALITY **JVC**[®] SERVICE

HOW TO LOCATE YOUR JVC SERVICE CENTER

TOLL FREE: 1 (800) 537-5722

<http://www.jvc.com>

Dear Customer,

In order to receive the most satisfaction from your purchase, please read the instruction booklet before operating the unit. In the event that repairs are necessary, please call 1 (800)537-5722 for your nearest authorized servicer or visit our website at **www.JVC.com**

Remember to retain your Bill of Sale for Warranty Service.

Do not service the television yourself

Caution

To prevent electrical shock, do not open the cabinet. There are no user serviceable parts inside. Please refer to qualified service personnel for repairs.

Accessories

To purchase accessories for your JVC product, please call toll free: 1 (800)882-2345 or on the web at **www.JVC.com**



LIMITED WARRANTY

AUDIO-1 **USA ONLY**

ONLY FOR PRODUCT PURCHASED IN U.S.A.

JVC COMPANY OF AMERICA warrants this product and all parts thereof, except as set forth below ONLY TO THE ORIGINAL PURCHASER AT RETAIL to be FREE FROM DEFECTIVE MATERIALS AND WORKMANSHIP from the date of original retail purchase for the period as shown below. ("The Warranty Period")

PARTS	1 YR	LABOR	1 YR
-------	-------------	-------	-------------

THIS LIMITED WARRANTY IS VALID ONLY IN THE FIFTY (50) UNITED STATES, THE DISTRICT OF COLUMBIA AND IN COMMONWEALTH OF PUERTO RICO.

WHAT WE WILL DO:

If this product is found to be defective, JVC will repair or replace defective parts at no charge to the original owner. Such repair and replacement services shall be rendered by JVC during normal business hours at JVC authorized service centers. Parts used for replacement are warranted only for the remainder of the Warranty Period. All products and parts thereof may be brought to a JVC authorized service center on a carry-in basis except for Television sets having a screen size 25 inches and above which are covered on an in-home basis.

WHAT YOU MUST DO FOR WARRANTY SERVICE:

Return your product to a JVC authorized service center with a copy of your bill of sale. For your nearest JVC authorized service center, please call toll free: (800) 537-5722.

If service is not available locally, box the product carefully, preferably in the original carton, and ship, insured, with a copy of your bill of sale plus a letter of explanation of the problem to the nearest JVC Factory Service Center, the name and location of which will be given to you by the toll-free number.

If you have any questions concerning your JVC Product, please contact our Customer Relations Department.

WHAT IS NOT COVERED:

This limited warranty provided by JVC does not cover:

1. Products which have been subject to abuse, accident, alteration, modification, tampering, negligence, misuse, faulty installation, lack of reasonable care, or if repaired or serviced by anyone other than a service facility authorized by JVC to render such service, or if affixed to any attachment not provided with the products, or if the model number or serial number has been altered, tampered with, defaced or removed;
2. Initial installation and installation and removal for repair;
3. Operational adjustments covered in the Owner's Manual, normal maintenance, video and audio head cleaning;
4. Damage that occurs in shipment, due to act of God, and cosmetic damage;
5. Signal reception problems and failures due to line power surge;
6. Video Pick-up Tubes/CCD Image Sensor, Cartridge, Stylus (Needle) are covered for 90 days from the date of purchase;
7. Batteries (except that Rechargeable Batteries are covered for 90 days from the date of purchase);

There are no express warranties except as listed above.

THE DURATION OF ANY IMPLIED WARRANTIES, INCLUDING THE IMPLIED WARRANTY OF MERCHANTABILITY, IS LIMITED TO THE DURATION OF THE EXPRESS WARRANTY HEREIN.

JVC SHALL NOT BE LIABLE FOR THE LOSS OF USE OF THE PRODUCT, INCONVENIENCE, LOSS OR ANY OTHER DAMAGES, WHETHER DIRECT, INCIDENTAL OR CONSEQUENTIAL (INCLUDING, WITHOUT LIMITATION, DAMAGE TO TAPES, RECORDS OR DISCS) RESULTING FROM THE USE OF THIS PRODUCT, OR ARISING OUT OF ANY BREACH OF THIS WARRANTY. ALL EXPRESS AND IMPLIED WARRANTIES, INCLUDING THE WARRANTIES OF MERCHANTABILITY AND FITNESS FOR PARTICULAR PURPOSE, ARE LIMITED TO THE WARRANTY PERIOD SET FORTH ABOVE.

Some states do not allow the exclusion of incidental or consequential damages or limitations on how long an implied warranty lasts, so these limitations or exclusions may not apply to you. This warranty gives you specific legal rights and you may also have other rights which vary from state to state.

JVC COMPANY OF AMERICA
DIVISION OF JVC AMERICAS CORP.

1700 Valley Road
Wayne, New Jersey 07470

REFURBISHED PRODUCTS CARRY A SEPARATE WARRANTY, THIS WARRANTY DOES NOT APPLY. FOR DETAILS OF REFURBISHED PRODUCT WARRANTY, PLEASE REFER TO THE REFURBISHED PRODUCT WARRANTY INFORMATION PACKAGED WITH EACH REFURBISHED PRODUCT.

For customer use:

Enter below the Model No. which is located either on the rear, bottom or side of the cabinet. Retain this information for future reference.

Model No. : _____

Serial No. : _____

Purchase data : _____

Name of dealer : _____



JVC
VICTOR COMPANY OF JAPAN, LIMITED